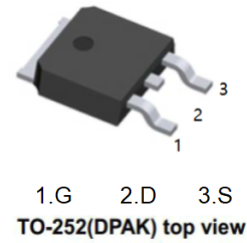


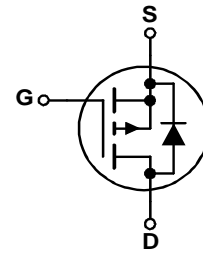
**Features**

- $V_{DS} (V) = -40V$
- $R_{DS(ON)} < 12.3m\Omega$  ( $V_{GS} = -10V$ )
- $R_{DS(ON)} < 18m\Omega$  ( $V_{GS} = -4.5V$ )
- High performance trench technology for extremely low  $r_{DS(on)}$
- RoHS Compliant



**Applications**

- Inverter
- Power Supplies



**MOSFET Maximum Ratings**  $T_C = 25^\circ C$  unless otherwise noted

Symbol	Parameter	Conditions	Ratings	Units
$V_{DS}$	Drain to Source Voltage		-40	V
$V_{GS}$	Gate to Source Voltage		$\pm 20$	V
$I_D$	Drain Current	-Continuous (Package limited) $T_C = 25^\circ C$	-50	A
		-Continuous (Silicon limited) $T_C = 25^\circ C$	-58	
		-Continuous $T_A = 25^\circ C$ (Note 1a)	-10.8	
		-Pulsed	-100	
$E_{AS}$	Single Pulse Avalanche Energy	(Note 3)	337	mJ
$P_D$	Power Dissipation	$T_C = 25^\circ C$	69	W
		$T_A = 25^\circ C$ (Note 1a)	2.4	
$T_J, T_{STG}$	Operating and Storage Junction Temperature Range		-55 to +150	$^\circ C$

**Thermal Characteristics**

$R_{\theta JC}$	Thermal Resistance, Junction to Case		1.8	$^\circ C/W$
$R_{\theta JA}$	Thermal Resistance, Junction to Ambient	(Note 1a)	52	

**Electrical Characteristics**  $T_J = 25^\circ\text{C}$  unless otherwise noted

Symbol	Parameter	Test Conditions	Min	Typ	Max	Units
--------	-----------	-----------------	-----	-----	-----	-------

**Off Characteristics**

$BV_{DSS}$	Drain to Source Breakdown Voltage	$I_D = -250\mu\text{A}, V_{GS} = 0\text{V}$	-40			V
$\Delta BV_{DSS} / \Delta T_J$	Breakdown Voltage Temperature Coefficient	$I_D = -250\mu\text{A}$ , referenced to $25^\circ\text{C}$		-29		mV/ $^\circ\text{C}$
$I_{DSS}$	Zero Gate Voltage Drain Current	$V_{DS} = -32\text{V}, V_{GS} = 0\text{V}$			-1	$\mu\text{A}$
$I_{GSS}$	Gate to Source Leakage Current	$V_{GS} = \pm 20\text{V}, V_{DS} = 0\text{V}$			$\pm 100$	nA

**On Characteristics**

$V_{GS(th)}$	Gate to Source Threshold Voltage	$V_{GS} = V_{DS}, I_D = -250\mu\text{A}$	-1	-1.8	-3	V
$\Delta V_{GS(th)} / \Delta T_J$	Gate to Source Threshold Voltage Temperature Coefficient	$I_D = -250\mu\text{A}$ , referenced to $25^\circ\text{C}$		5.8		mV/ $^\circ\text{C}$
$r_{DS(on)}$	Static Drain to Source On Resistance	$V_{GS} = -10\text{V}, I_D = -12.7\text{A}$		10.1	12.3	m $\Omega$
		$V_{GS} = -4.5\text{V}, I_D = -10.4\text{A}$		14.5	18.0	
$g_{FS}$	Forward Transconductance	$V_{DS} = -5\text{V}, I_D = -12.7\text{A}$		38		S

**Dynamic Characteristics**

$C_{iss}$	Input Capacitance	$V_{DS} = -20\text{V}, V_{GS} = 0\text{V}, f = 1\text{MHz}$		2085	2775	pF
$C_{oss}$	Output Capacitance			360	480	pF
$C_{rss}$	Reverse Transfer Capacitance			210	310	pF
$R_g$	Gate Resistance	$f = 1\text{MHz}$		4.6		$\Omega$

**Switching Characteristics**

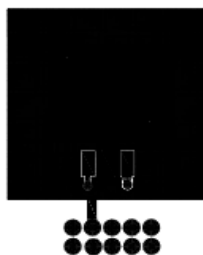
$t_{d(on)}$	Turn-On Delay Time	$V_{DD} = -20\text{V}, I_D = -12.7\text{A}, V_{GS} = -10\text{V}, R_{GEN} = 6\Omega$		10	19	ns
$t_r$	Rise Time			7	13	ns
$t_{d(off)}$	Turn-Off Delay Time			38	60	ns
$t_f$	Fall Time			15	27	ns
$Q_g$	Total Gate Charge	$V_{GS} = 0\text{V to } -10\text{V}$	$V_{DD} = -20\text{V}, I_D = -12.7\text{A}$	36	50	nC
$Q_g$	Total Gate Charge	$V_{GS} = 0\text{V to } -5\text{V}$		19	27	nC
$Q_{gs}$	Gate to Source Charge			7		nC
$Q_{gd}$	Gate to Drain "Miller" Charge			8		nC

**Drain-Source Diode Characteristics**

$V_{SD}$	Source to Drain Diode Forward Voltage	$V_{GS} = 0\text{V}, I_S = -12.7\text{A}$ (Note 2)		-0.8	-1.2	V
$t_{rr}$	Reverse Recovery Time	$I_F = -12.7\text{A}, di/dt = 100\text{A}/\mu\text{s}$		29	44	ns
$Q_{rr}$	Reverse Recovery Charge			26	40	nC

Notes:

1:  $R_{\theta JA}$  is the sum of the junction-to-case and case-to-ambient thermal resistance where the case thermal reference is defined as the solder mounting surface of the drain pins.  $R_{\theta JC}$  is guaranteed by design while  $R_{\theta JA}$  is determined by the user's board design.



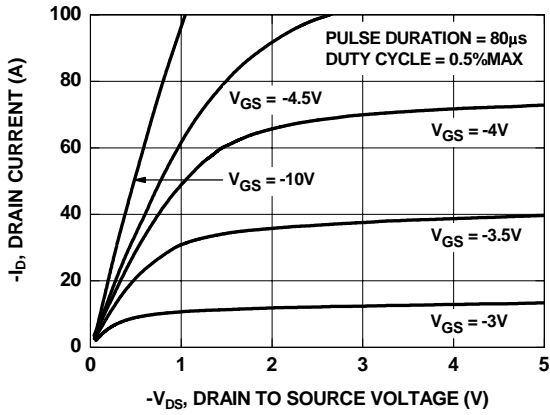
a)  $52^\circ\text{C}/\text{W}$  when mounted on a  $1\text{ in}^2$  pad of 2 oz copper



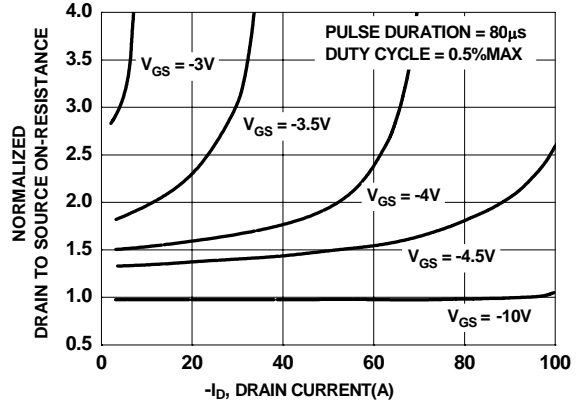
b)  $100^\circ\text{C}/\text{W}$  when mounted on a minimum pad.

2: Pulse Test: Pulse Width <  $300\mu\text{s}$ , Duty cycle < 2.0%.  
3: Starting  $T_J = 25^\circ\text{C}$ ,  $L = 3\text{mH}$ ,  $I_{AS} = 15\text{A}$ ,  $V_{DD} = 40\text{V}$ ,  $V_{GS} = 10\text{V}$ .

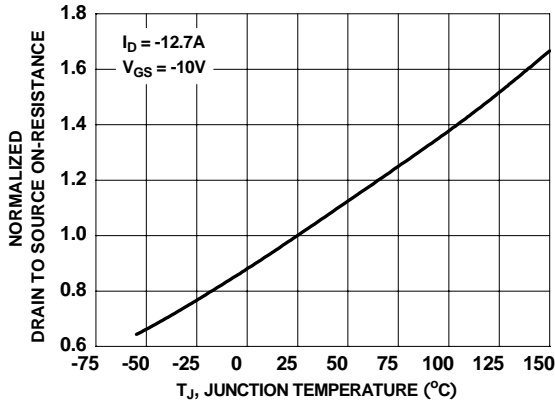
**Typical Characteristics**  $T_J = 25^\circ\text{C}$  unless otherwise noted



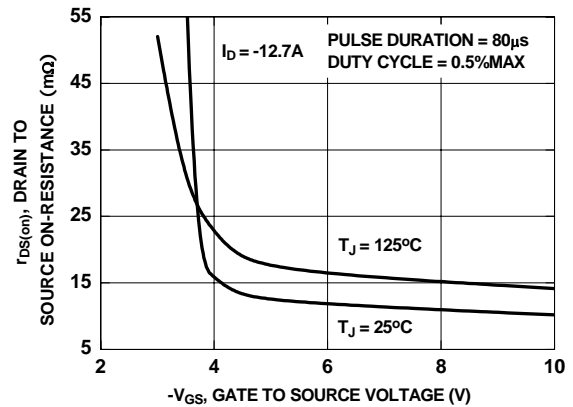
**Figure 1. On-Region Characteristics**



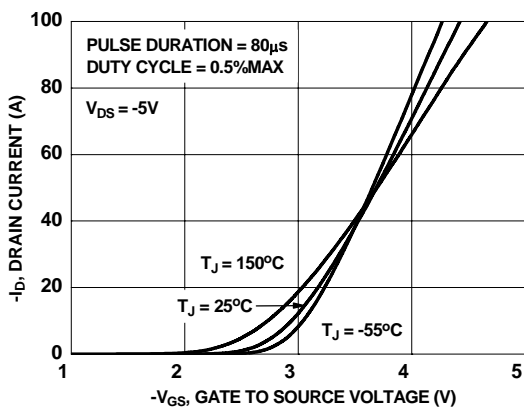
**Figure 2. Normalized On-Resistance vs Drain Current and Gate Voltage**



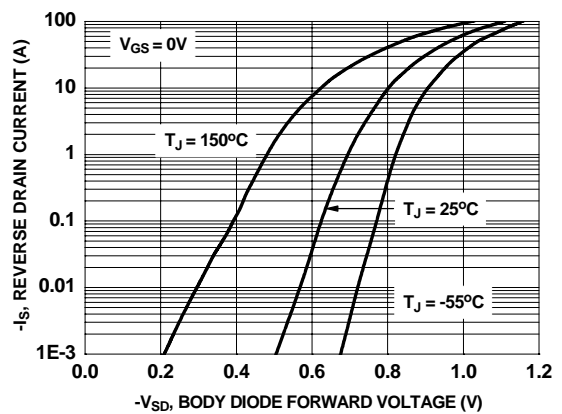
**Figure 3. Normalized On-Resistance vs Junction Temperature**



**Figure 4. On-Resistance vs Gate to Source Voltage**

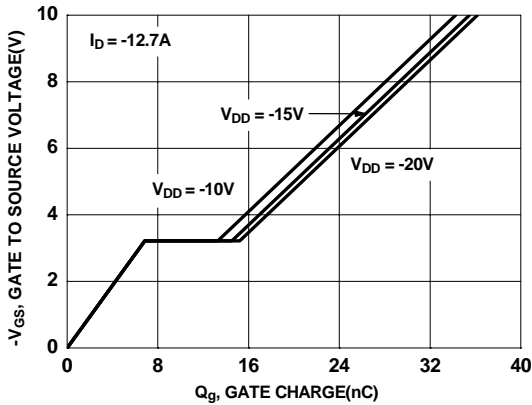


**Figure 5. Transfer Characteristics**

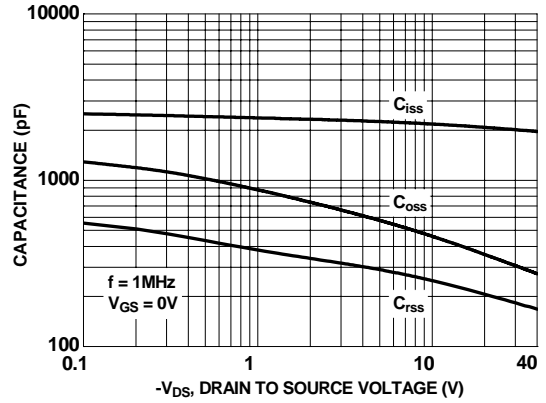


**Figure 6. Source to Drain Diode Forward Voltage vs Source Current**

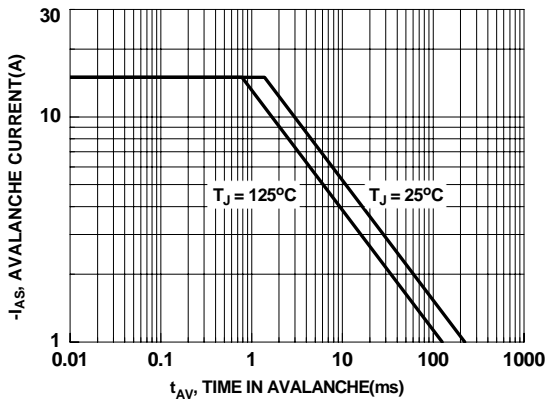
**Typical Characteristics**  $T_J = 25^\circ\text{C}$  unless otherwise noted



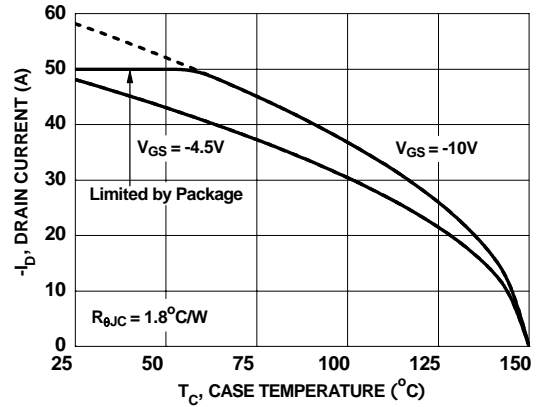
**Figure 7. Gate Charge Characteristics**



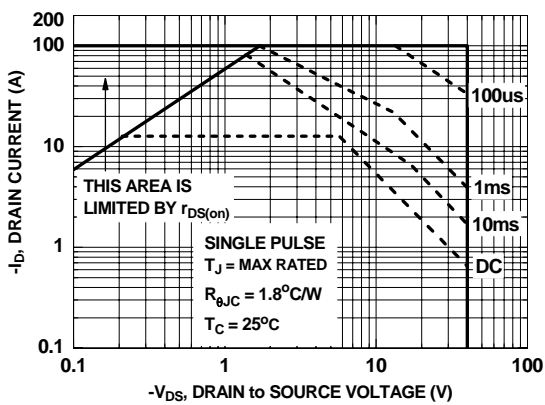
**Figure 8. Capacitance vs Drain to Source Voltage**



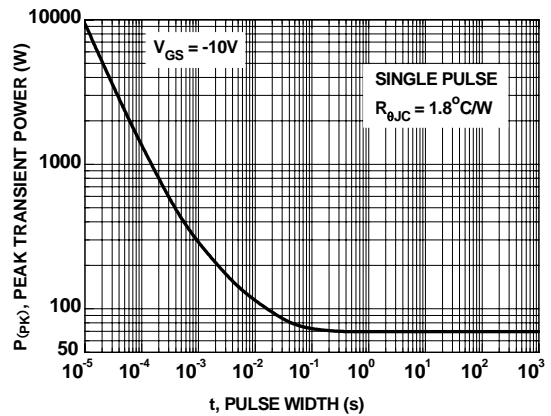
**Figure 9. Unclamped Inductive Switching Capability**



**Figure 10. Maximum Continuous Drain Current vs Case Temperature**

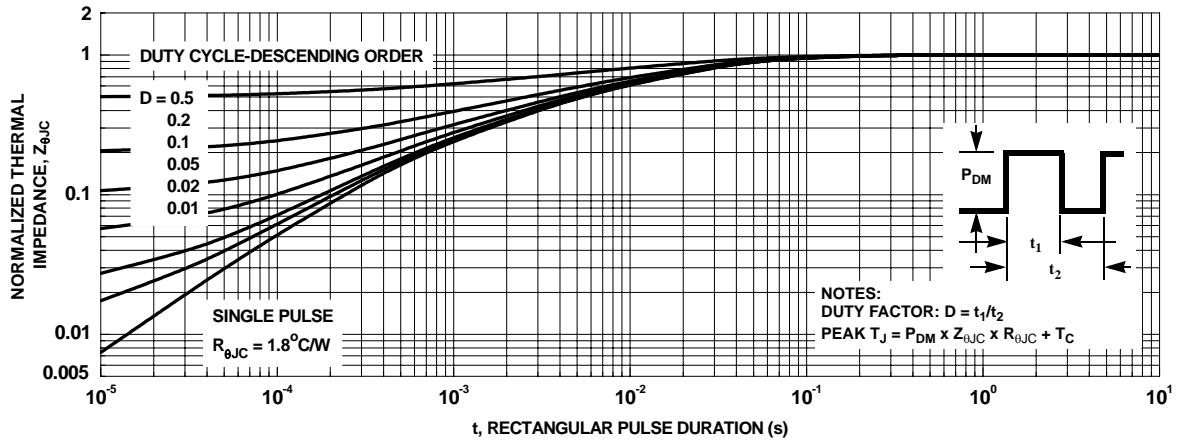


**Figure 11. Forward Bias Safe Operating Area**

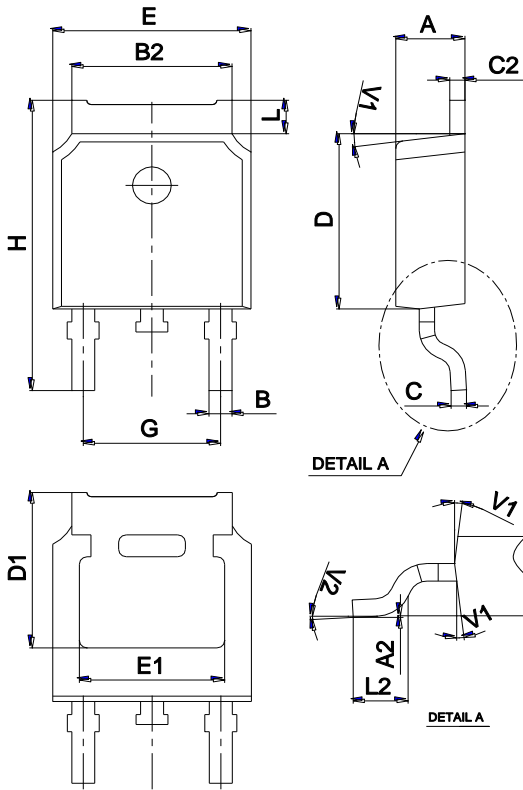


**Figure 12. Single Pulse Maximum Power Dissipation**

**Typical Characteristics**  $T_J = 25^\circ\text{C}$  unless otherwise noted

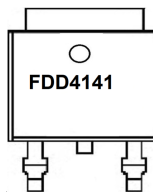


**Package Mechanical Data TO-252**



Ref.	Dimensions					
	Millimeters			Inches		
	Min.	Typ.	Max.	Min.	Typ.	Max.
A	2.10		2.50	0.083		0.098
A2	0		0.10	0		0.004
B	0.66		0.86	0.026		0.034
B2	5.18		5.48	0.202		0.216
C	0.40		0.60	0.016		0.024
C2	0.44		0.58	0.017		0.023
D	5.90		6.30	0.232		0.248
D1	5.30REF			0.209REF		
E	6.40		6.80	0.252		0.268
E1	4.63			0.182		
G	4.47		4.67	0.176		0.184
H	9.50		10.70	0.374		0.421
L	1.09		1.21	0.043		0.048
L2	1.35		1.65	0.053		0.065
V1		7°			7°	
V2	0°		6°	0°		6°

**Marking**



**Ordering information**

Order code	Package	Baseqty	Deliverymode
FDD4141	TO-252	2500	Tape and reel