

Features

- P-Channel
- Enhancement mode
- Avalanche rated
- dv/dt rated
- 175°C operating temperature

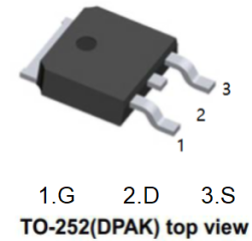

Product Summary

- $V_{DS} (V) = -60V$
- $R_{DS(on)} = 75 \text{ m}\Omega$ ($V_{GS} = -10V$)
- $I_D = -30A$ ($V_{GS} = -10V$)

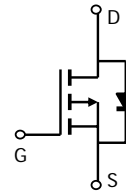

Maximum Ratings, at $T_j = 25 \text{ }^\circ\text{C}$, unless otherwise specified

Parameter	Symbol	Value	Unit
Continuous drain current $T_C = 25 \text{ }^\circ\text{C}$ $T_C = 100 \text{ }^\circ\text{C}$	I_D	-30 -21.5	A
Pulsed drain current $T_C = 25 \text{ }^\circ\text{C}$	$I_D \text{ puls}$	-120	
Avalanche energy, single pulse $I_D = -30 \text{ A}$, $V_{DD} = -25 \text{ V}$, $R_{GS} = 25 \text{ }\Omega$	E_{AS} mJ	250	mJ
Avalanche energy, periodic limited by T_{jmax}	E_{AR}	12.5	
Reverse diode dv/dt $I_S = -30 \text{ A}$, $V_{DS} = -48 \text{ V}$, $di/dt = 200 \text{ A}/\mu\text{s}$, $T_{jmax} = 175 \text{ }^\circ\text{C}$	dv/dt	6	kV/ μs
Gate source voltage	V_{GS}	± 20	V
Power dissipation $T_C = 25 \text{ }^\circ\text{C}$	P_{tot} W	125	W
Operating and storage temperature	T_j, T_{stg}	-55+175	$^\circ\text{C}$
IEC climatic category; DIN IEC 68-1		55/175/56	

Thermal Characteristics

Parameter	Symbol	Values			Unit
		min.	typ.	max.	
Characteristics					
Thermal resistance, junction - case	R_{thJC}			1.2	K/W
Thermal resistance, junction - ambient, leaded	R_{thJA}			100	
SMD version, device on PCB: @ min. footprint @ 6 cm ² cooling area ¹⁾	R_{thJA}			75 50	

Electrical Characteristics, at $T_j = 25\text{ °C}$, unless otherwise specified

Parameter	Symbol	Values			Unit
		min.	typ.	max.	
Static Characteristics					
Drain- source breakdown voltage $V_{GS} = 0\text{ V}$, $I_D = -250\text{ }\mu\text{A}$	$V_{(BR)DSS}$	-60			V
Gate threshold voltage, $V_{GS} = V_{DS}$ $I_D = -1.7\text{ mA}$	$V_{GS(th)}$	-2.1	-3	-4	
Zero gate voltage drain current $V_{DS} = -60\text{ V}$, $V_{GS} = 0\text{ V}$, $T_j = 25\text{ °C}$ $V_{DS} = -60\text{ V}$, $V_{GS} = 0\text{ V}$, $T_j = 150\text{ °C}$	I_{DSS}		-0.1 -10	-1 -100	μA
Gate-source leakage current $V_{GS} = -20\text{ V}$, $V_{DS} = 0\text{ V}$	I_{GSS}		-10	-100	nA
Drain-source on-state resistance $V_{GS} = -10\text{ V}$, $I_D = -21.5\text{ A}$	$R_{DS(on)}$		69	75	m Ω

Electrical Characteristics, at $T_j = 25\text{ °C}$, unless otherwise specified

Parameter	Symbol	Values			Unit
		min.	typ.	max.	
Dynamic Characteristics					
Transconductance $V_{DS} \geq 2 \cdot I_D \cdot R_{DS(on)max}$, $I_D = -21.5\text{ A}$	g_{fs}	5.2	10.4		S
Input capacitance $V_{GS} = 0\text{ V}$, $V_{DS} = -25\text{ V}$, $f = 1\text{ MHz}$	C_{iss}		1228	1535	pF
Output capacitance $V_{GS} = 0\text{ V}$, $V_{DS} = -25\text{ V}$, $f = 1\text{ MHz}$	C_{oss}		387	383	
Reverse transfer capacitance $V_{GS} = 0\text{ V}$, $V_{DS} = -25\text{ V}$, $f = 1\text{ MHz}$	C_{rss}		142	177	
Turn-on delay time $V_{DD} = -30\text{ V}$, $V_{GS} = -10\text{ V}$, $I_D = -21.5\text{ A}$, $R_G = 1.6\ \Omega$	$t_{d(on)}$		13	19.5	ns
Rise time $V_{DD} = -30\text{ V}$, $V_{GS} = -10\text{ V}$, $I_D = -21.5\text{ A}$, $R_G = 1.6\ \Omega$	t_r		11	16.5	
Turn-off delay time $V_{DD} = -30\text{ V}$, $V_{GS} = -10\text{ V}$, $I_D = -21.5\text{ A}$, $R_G = 1.6\ \Omega$	$t_{d(off)}$		30	45	
Fall time $V_{DD} = -30\text{ V}$, $V_{GS} = -10\text{ V}$, $I_D = -21.5\text{ A}$, $R_G = 1.6\ \Omega$	t_f		20	30	

Electrical Characteristics, at T_j = 25 °C, unless

Parameter	Symbol	Values			Unit
		min.	typ.	max.	
Dynamic Characteristics					
Gate to source charge V _{DD} = -48 V, I _D = -30 A	Q _{gs}		3.7	5.6	nC
Gate to drain charge V _{DD} = -48 V, I _D = -30 A	Q _{gd}		13.8	20.7	
Gate charge total V _{DD} = -48 V, I _D = -30 A, V _{GS} = 0 to -10 V	Q _g		32	48	
Gate plateau voltage V _{DD} = -48 V, I _D = -30 A	V _(plateau)		-5.2		V
Parameter	Symbol	Values			Unit
		min.	typ.	max.	
Reverse Diode					
Inverse diode continuous forward current T _C = 25 °C	I _S			-30	A
Inverse diode direct current, pulsed T _C = 25 °C	I _{SM}			-120	
Inverse diode forward voltage V _{GS} = 0 V, I _F = -30	V _{SD}		-1.3	-1.7	V
Reverse recovery time V _R = -30 V, I _F = I _S , di _F /dt = 100 A/μs	t _{rr}		64.6	97	ns
Reverse recovery charge V _R = -30 V, I _F = I _S , di _F /dt = 100 A/μs	Q _{rr}		153	230	nC

Power dissipation

$P_{tot} = f(T_C)$

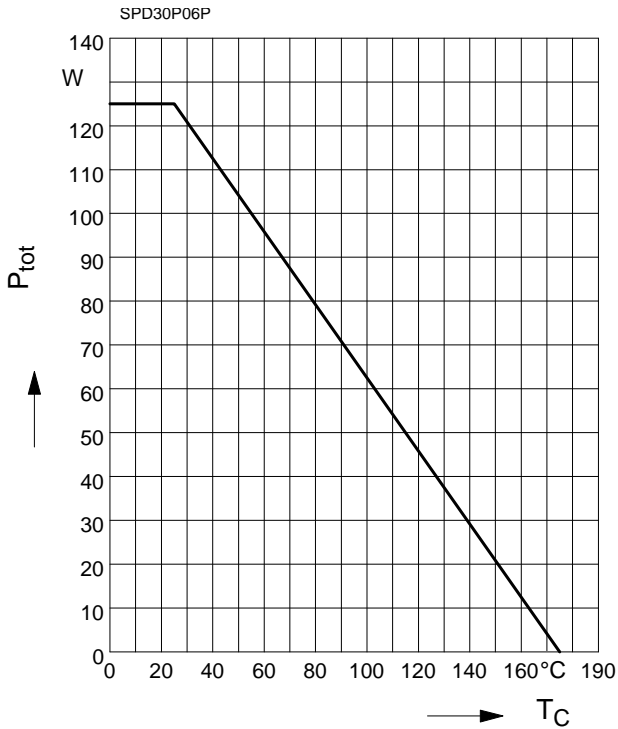

Drain current

$I_D = f(T_C)$

parameter: $V_{GS} \geq 10\text{ V}$

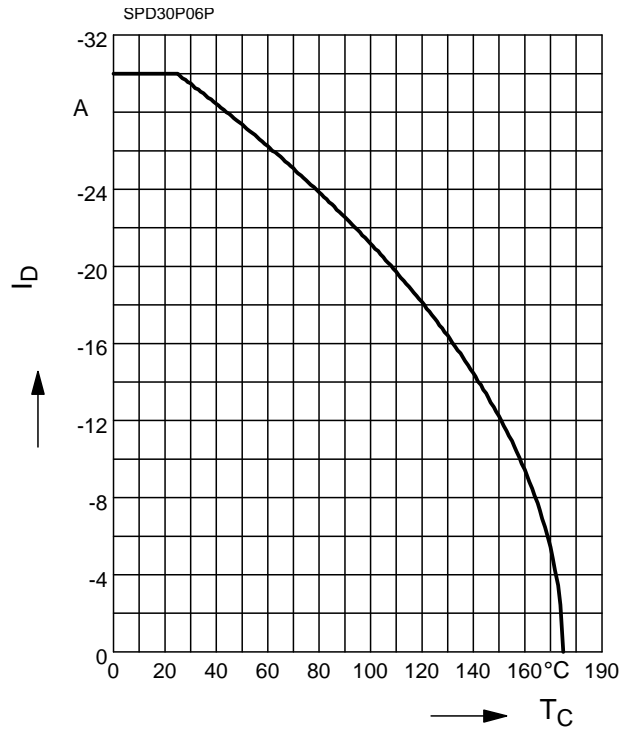

Safe operating area

$I_D = f(V_{DS})$

parameter: $D = 0$, $T_C = 25\text{ °C}$

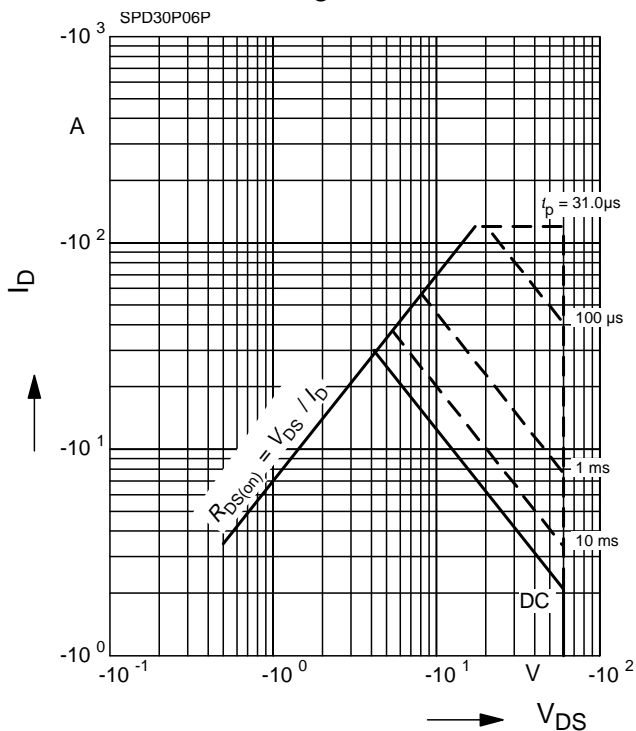

Transient thermal impedance

$Z_{thJC} = f(t_p)$

parameter: $D = t_p/T$

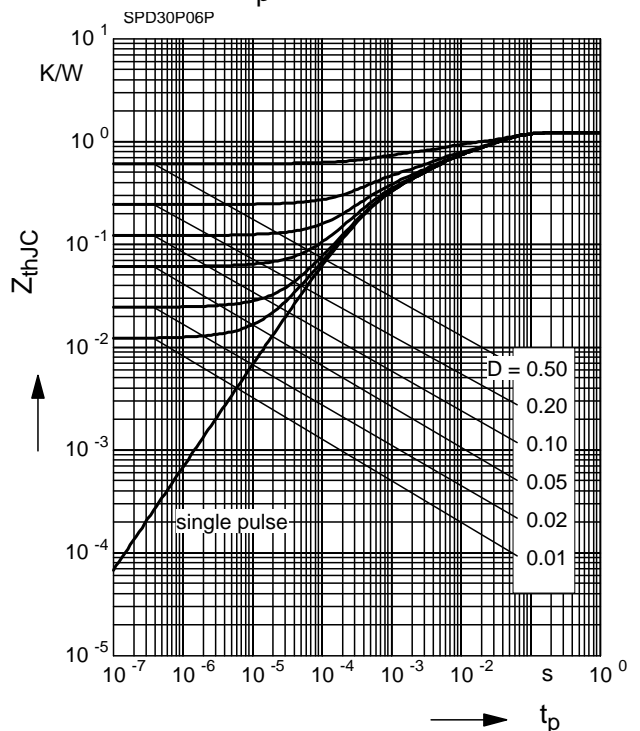

Typ. output characteristic

$I_D = f(V_{DS}); T_J = 25^\circ\text{C}$

parameter: $t_p = 80 \mu\text{s}$

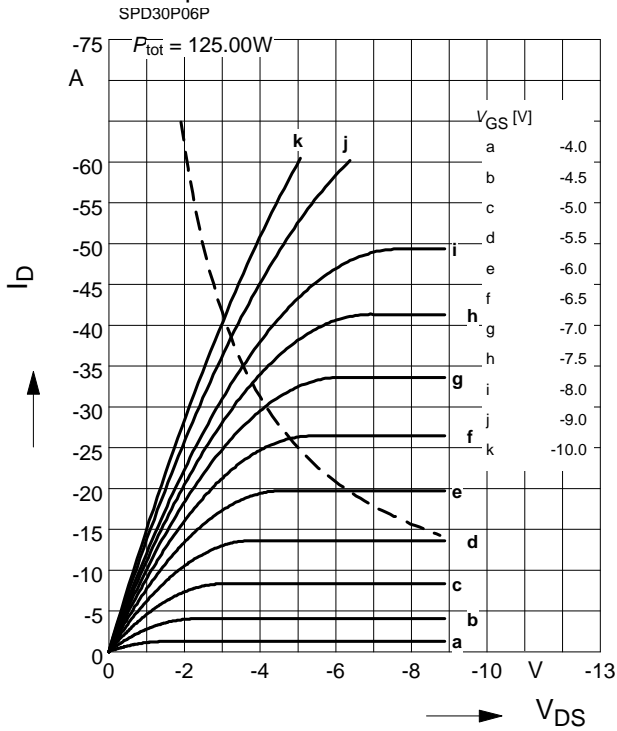

Typ. drain-source-on-resistance

$R_{DS(on)} = f(I_D)$

parameter: V_{GS}

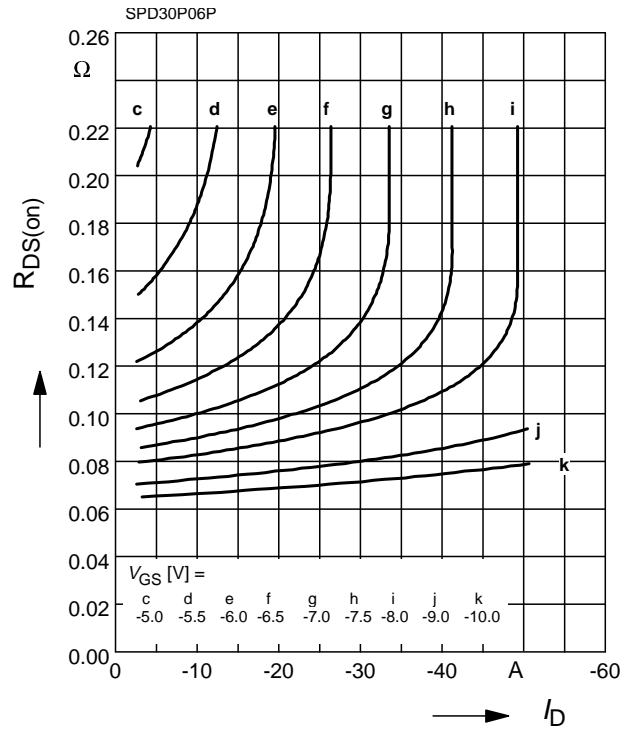

Typ. transfer characteristics $I_D = f(V_{GS})$

$V_{DS} \geq 2 \times I_D \times R_{DS(on)max}$

parameter: $t_p = 80 \mu\text{s}$

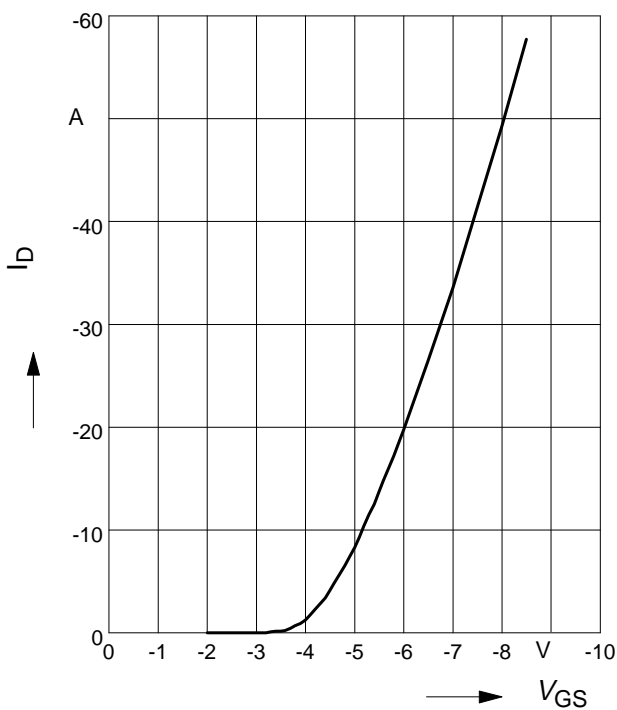

Typ. forward transconductance

$g_{fs} = f(I_D); T_J = 25^\circ\text{C}$

parameter: g_{fs}

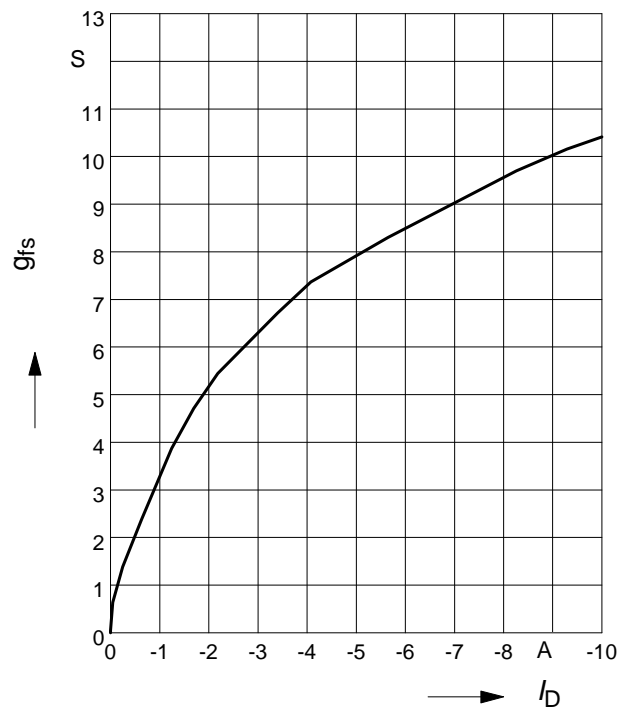

Drain-source on-state resistance

$R_{DS(on)} = f(T_j)$

parameter: $I_D = -21.5 \text{ A}$, $V_{GS} = -10 \text{ V}$

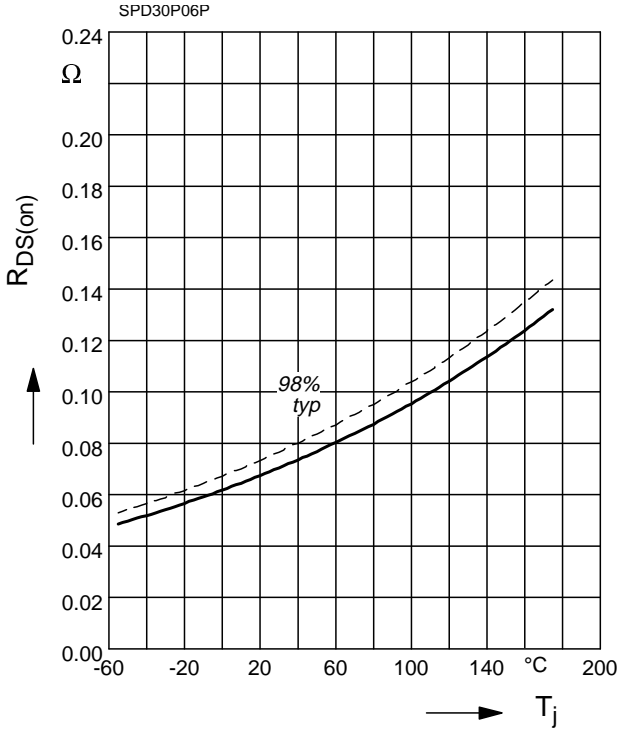

Gate threshold voltage

$V_{GS(th)} = f(T_j)$

parameter: $V_{GS} = V_{DS}$, $I_D = -1.7 \text{ mA}$

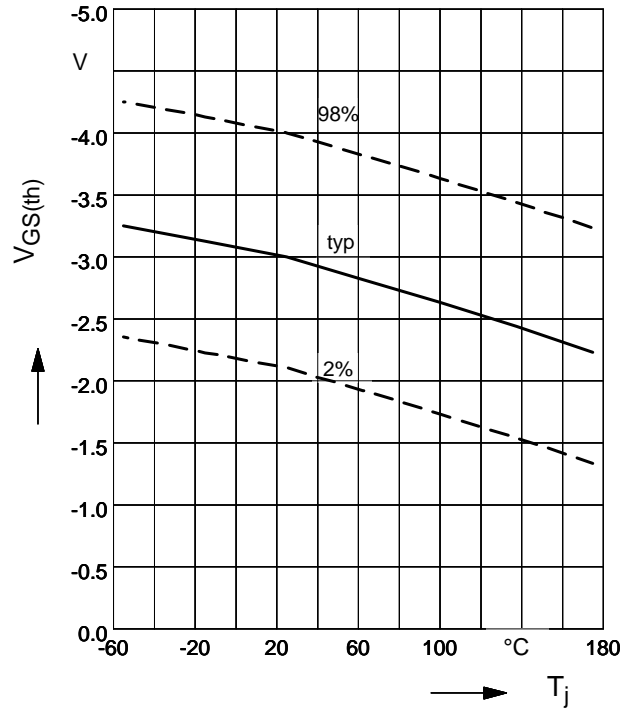

Typ. capacitances

$C = f(V_{DS})$

parameter: $V_{GS}=0\text{V}$, $f=1 \text{ MHz}$

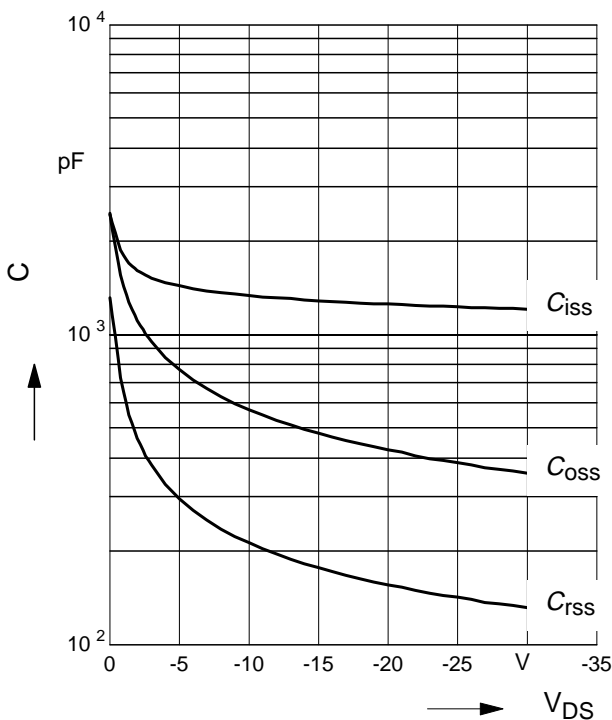

Forward characteristics of reverse diode

$I_F = f(V_{SD})$

parameter: T_j , $t_p = 80 \mu\text{s}$

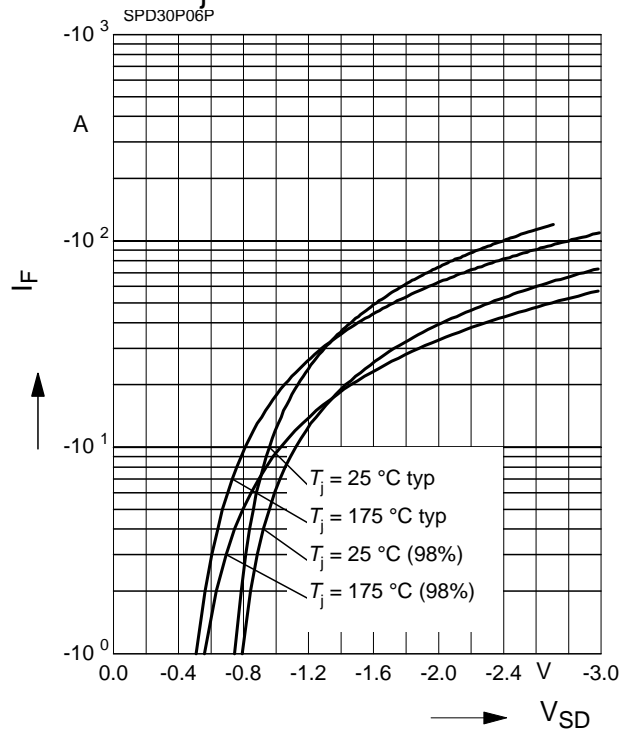

Avalanche energy

$E_{AS} = f(T_j)$

para.: $I_D = -30\text{ A}$, $V_{DD} = -25\text{ V}$, $R_{GS} = 25\ \Omega$

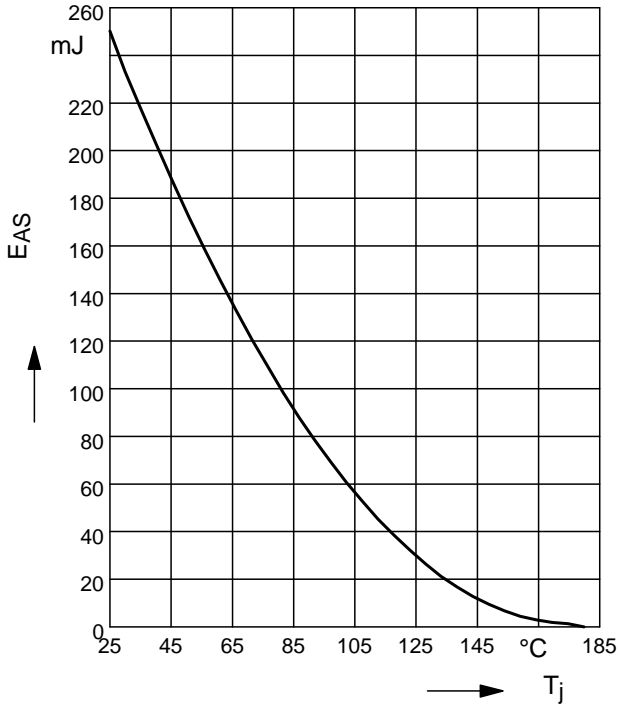

Typ. gate charge

$V_{GS} = f(Q_{Gate})$

parameter: $I_D = -30\text{ A}$ pulsed

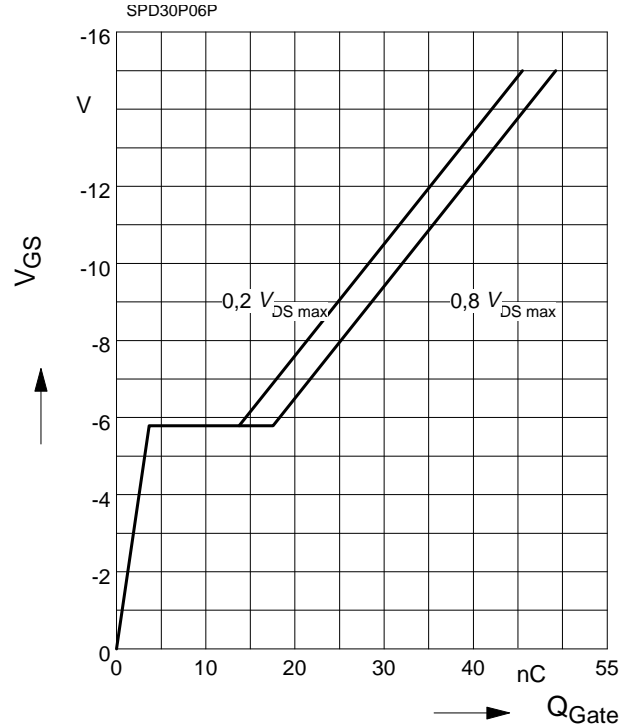

Drain-source breakdown voltage

$V_{(BR)DSS} = f(T_j)$

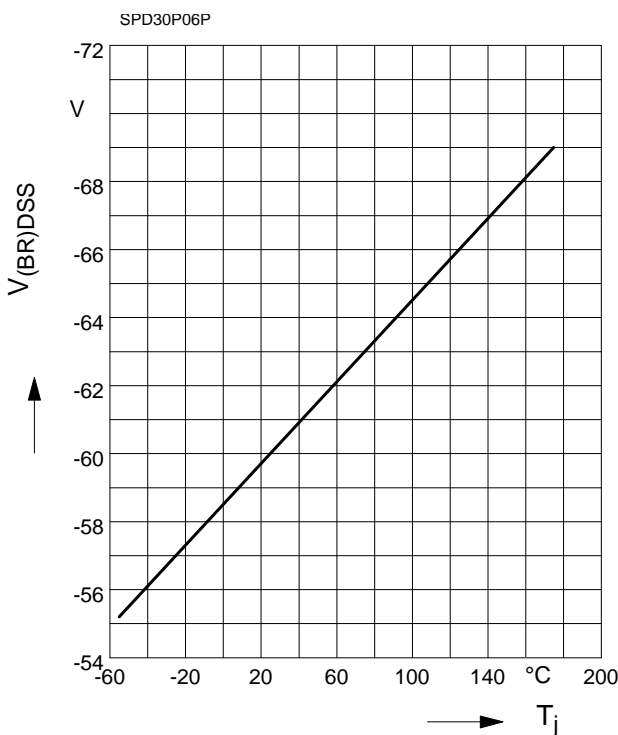

Package Mechanical Data TO-252

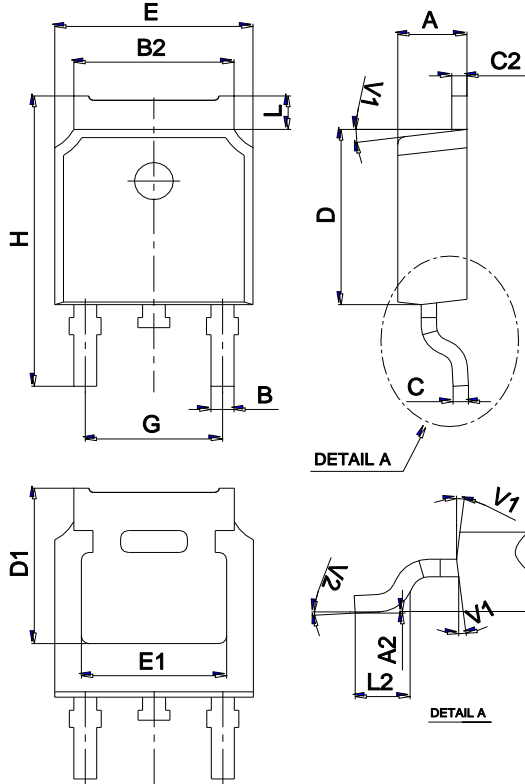

Ref.	Dimensions					
	Millimeters			Inches		
	Min.	Typ.	Max.	Min.	Typ.	Max.
A	2.10		2.50	0.083		0.098
A2	0		0.10	0		0.004
B	0.66		0.86	0.026		0.034
B2	5.18		5.48	0.202		0.216
C	0.40		0.60	0.016		0.024
C2	0.44		0.58	0.017		0.023
D	5.90		6.30	0.232		0.248
D1	5.30REF			0.209REF		
E	6.40		6.80	0.252		0.268
E1	4.63			0.182		
G	4.47		4.67	0.176		0.184
H	9.50		10.70	0.374		0.421
L	1.09		1.21	0.043		0.048
L2	1.35		1.65	0.053		0.065
V1		7°			7°	
V2	0°		6°	0°		6°

Marking

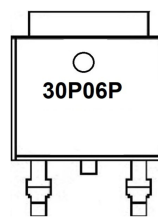

Ordering information

Order code	Package	Baseqty	Deliverymode
SPD30P6PG	TO-252	2500	Tape and reel