

**60V N-Channel Enhancement Mode Power MOSFET**

**General Description**

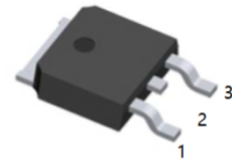
The IRLR2905TR uses advanced trench technology and design to provide excellent  $R_{DS(ON)}$  with low gate charge. It can be used in a wide variety of applications.

**Features**

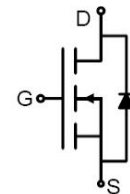
- $V_{DS} = 60V, I_D = 30A$   
 $R_{DS(ON)}, 23m\Omega$  (Typ) @  $V_{GS} = 10V$   
 $R_{DS(ON)}, 29m\Omega$  (Typ) @  $V_{GS} = 4.5V$
- Advanced Trench Technology
- Excellent  $R_{DS(ON)}$  and Low Gate Charge
- Lead free product is acquired

**Application**

- Load Switch
- PWM Application
- Power management



1.G 2.D 3.S  
**TO-252(DPAK) top view**



**Schematic Diagram**

**Absolute Maximum Ratings(TA=25°C unless otherwise noted)**

Parameter		Symbol	Value	Unit
Drain-Source Voltage		$V_{DS}$	60	V
Gate-Source Voltage		$V_{GS}$	±20	V
Drain Current-Continuous <sup>Note3</sup>	TC=25°C	$I_D$	30	A
	TC=100°C		20	A
Drain Current-Pulsed <sup>Note1</sup>		$I_{DM}$	120	A
Avalanche Energy <sup>Note4</sup>		$E_{AS}$	72	mJ
Maximum Power Dissipation	TC=25°C	$P_D$	55	W
Storage Temperature Range		$T_{STG}$	-55 to +150	°C
Operating Junction Temperature Range		$T_J$	-55 to +150	°C

**Thermal Resistance**

Parameter	Symbol	Min.	Typ.	Max	Unit
Thermal Resistance, Junction-to-Case	$R_{\theta JC}$	-	-	2.7	°C/W

**60V N-Channel Enhancement Mode Power MOSFET**
**Electrical Characteristics(T<sub>J</sub>=25°C unless otherwise noted)**

OFF CHARACTERISTICS						
Parameter	Symbol	Conditions	Min.	Typ.	Max.	Unit
Drain-Source Breakdown Voltage	BV <sub>DSS</sub>	V <sub>GS</sub> =0V, I <sub>DS</sub> =250uA	60	-	-	V
Zero Gate Voltage Drain Current	I <sub>DSS</sub>	V <sub>DS</sub> =60V, V <sub>GS</sub> =0V	-	-	1	uA
Gate-Body Leakage	I <sub>GSS</sub>	V <sub>GS</sub> =±20V, V <sub>DS</sub> =0V	-	-	±100	nA

ON CHARACTERISTICS						
Parameter	Symbol	Conditions	Min.	Typ.	Max.	Unit
Gate Threshold Voltage	V <sub>GS(TH)</sub>	V <sub>DS</sub> =V <sub>GS</sub> , I <sub>DS</sub> =250uA	1.0	1.6	2.5	V
Drain-Source On-State Resistance	R <sub>DS(ON)</sub>	V <sub>GS</sub> =10V, I <sub>DS</sub> =15A	-	23	29	mΩ
		V <sub>GS</sub> =4.5V, I <sub>DS</sub> =10A	-	29	40	mΩ

DYNAMIC CHARACTERISTICS						
Parameter	Symbol	Conditions	Min.	Typ.	Max.	Unit
Input Capacitance	C <sub>ISS</sub>	V <sub>DS</sub> =25V, V <sub>GS</sub> = 0V, f=1MHz	-	1562	-	pF
Output Capacitance	C <sub>OSS</sub>		-	75.4	-	
Reverse Transfer Capacitance	C <sub>rss</sub>		-	66.8	-	

SWITCHING CHARACTERISTICS						
Parameter	Symbol	Conditions	Min.	Typ.	Max.	Unit
Turn-On Delay Time	T <sub>d(on)</sub>	V <sub>GS</sub> =10V, V <sub>DS</sub> =30V, R <sub>GEN</sub> =1.8Ω I <sub>D</sub> =15A	-	7.5	-	ns
Rise Time	t <sub>r</sub>		-	21	-	
Turn-Off Delay Time	T <sub>d(off)</sub>		-	16	-	
Fall Time	t <sub>f</sub>		-	23.5	-	
Total Gate Charge at 10V	Q <sub>g</sub>	V <sub>DS</sub> =30V, I <sub>DS</sub> =15A, V <sub>GS</sub> =10V	-	25	-	nC
Gate to Source Gate Charge	Q <sub>gs</sub>		-	4.5	-	
Gate to Drain "Miller" Charge	Q <sub>gd</sub>		-	6.5	-	

DRAIN-SOURCE DIODE CHARACTERISTICS AND MAXIMUM RATINGS						
Parameter	Symbol	Conditions	Min.	Typ.	Max.	Unit
Drain-Source Diode Forward Voltage	V <sub>SD</sub>	V <sub>GS</sub> =0V, I <sub>DS</sub> =15A	-	-	1.2	V
Reverse Recovery Time	t <sub>rr</sub>	T <sub>J</sub> =25°C, I <sub>F</sub> =15A di/dt=100A/us	-	29	-	nS
Reverse Recovery Charge	Q <sub>rr</sub>		-	45	-	nC

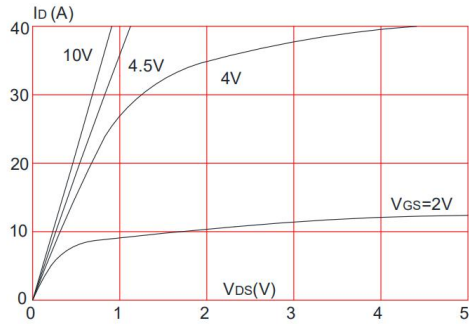
**Notes:**

- 1: Repetitive rating, pulse width limited by maximum junction temperature.
- 2: Surface mounted on FR4 Board, t<sub>s</sub>≤10sec.
- 3: Pulse width ≤ 300μs, duty cycle ≤ 2%.
- 4: EAS condition: L=0.5mH, V<sub>DD</sub>=30V, V<sub>G</sub>=10V, V<sub>GATE</sub>=60V, Start T<sub>J</sub>=25°C.

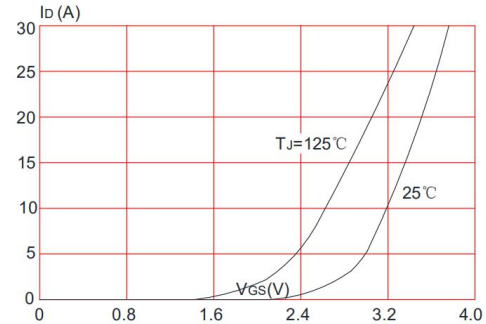
**60V N-Channel Enhancement Mode Power MOSFET**

**Typical Performance Characteristics**

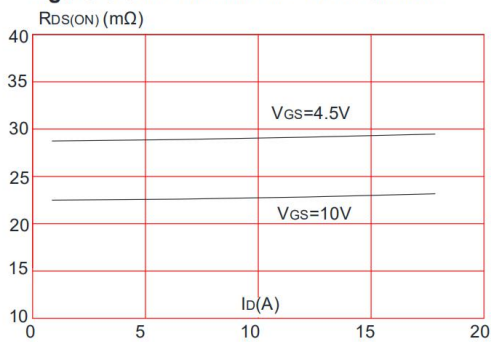
**Figure 1: Output Characteristics**



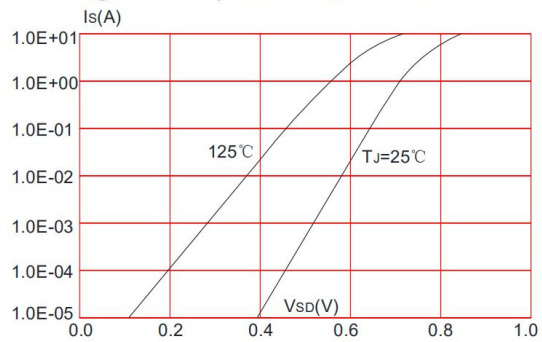
**Figure 2: Typical Transfer Characteristics**



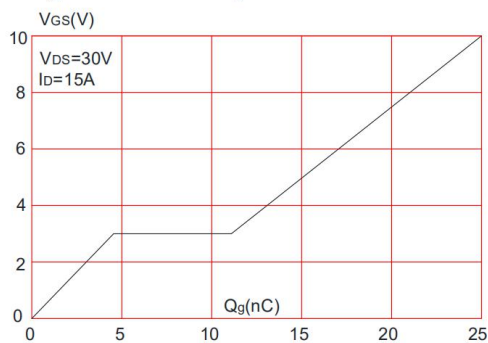
**Figure 3: On-resistance vs. Drain Current**



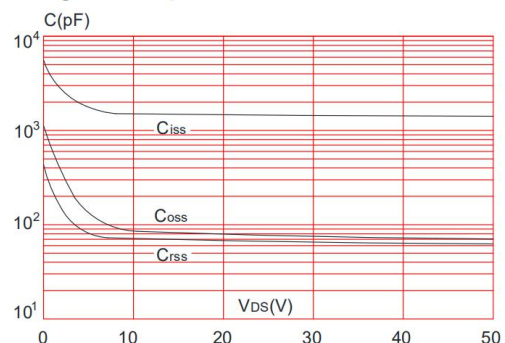
**Figure 4: Body Diode Characteristics**



**Figure 5: Gate Charge Characteristics**

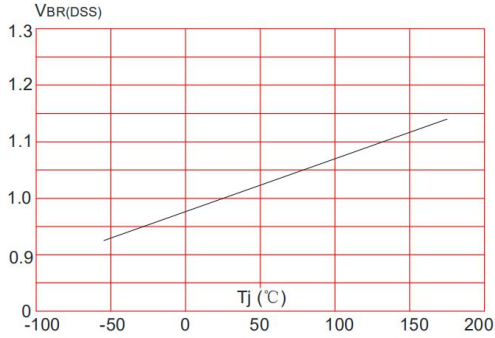


**Figure 6: Capacitance Characteristics**

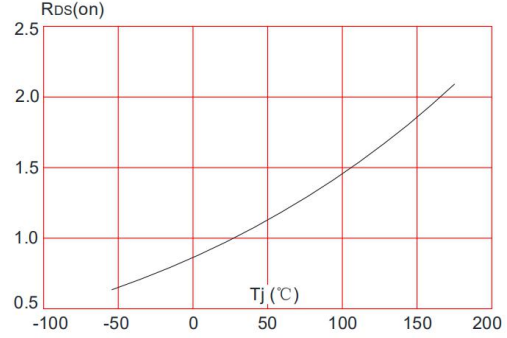


**60V N-Channel Enhancement Mode Power MOSFET**

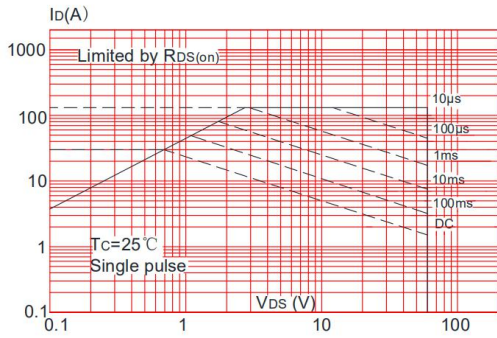
**Figure 7:** Normalized Breakdown Voltage vs. Junction Temperature



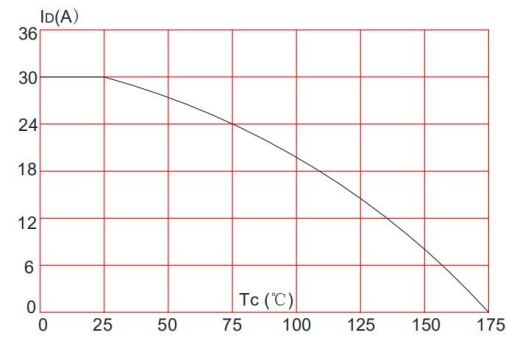
**Figure 8:** Normalized on Resistance vs. Junction Temperature



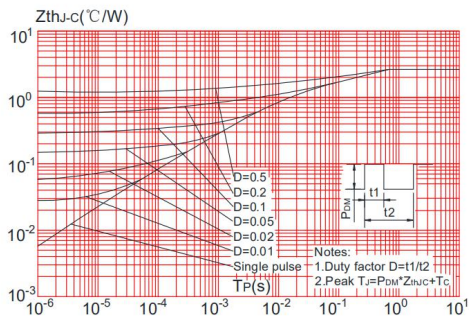
**Figure 9:** Maximum Safe Operating Area



**Figure 10:** Maximum Continuous Drain Current vs. Case Temperature



**Figure.11:** Maximum Effective Transient Thermal Impedance, Junction-to-Case



**60V N-Channel Enhancement Mode Power MOSFET**

**Test Circuit**

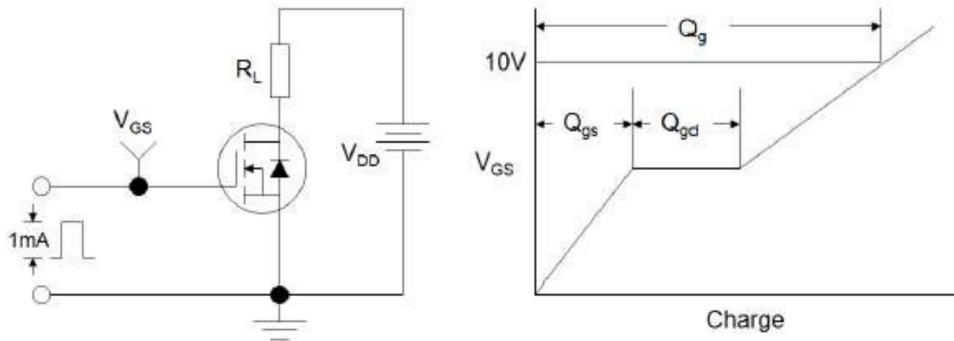


Figure1:Gate Charge Test Circuit & Waveform

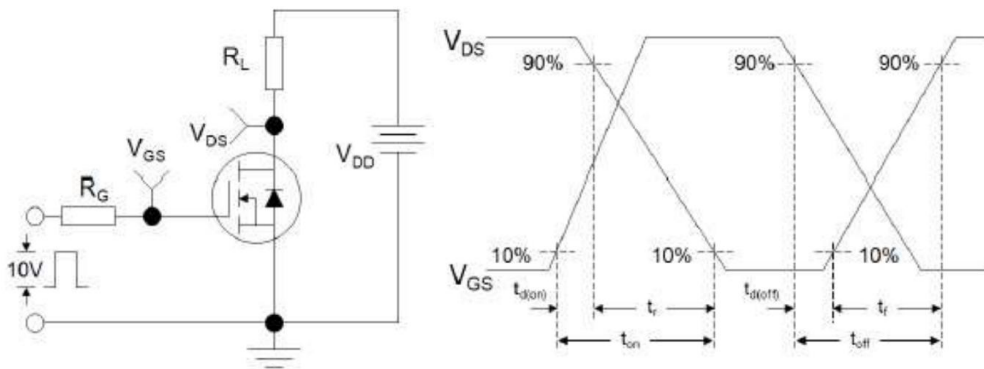


Figure 2: Resistive Switching Test Circuit & Waveforms

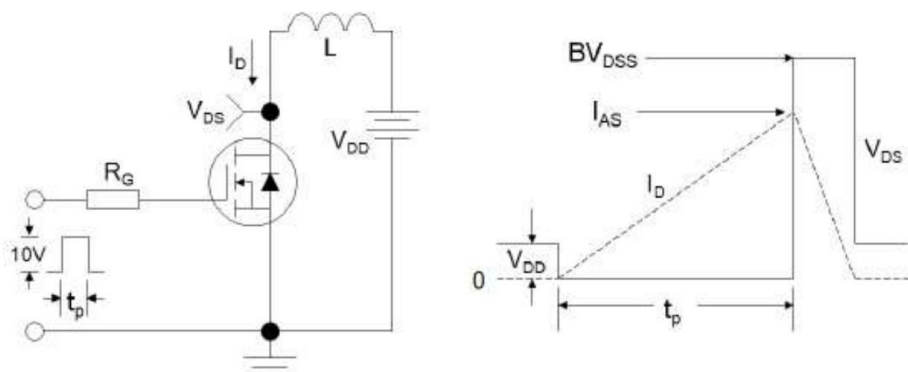
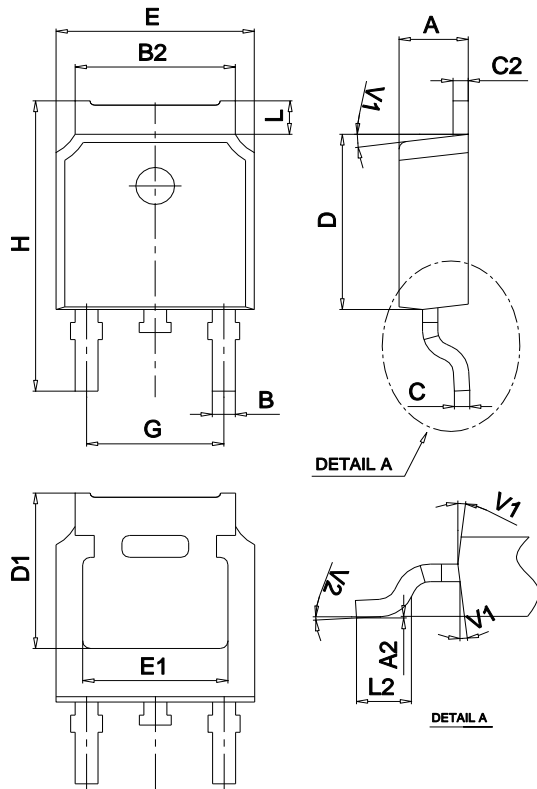


Figure 3:Unclamped Inductive Switching Test Circuit & Waveforms

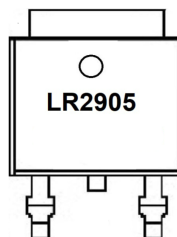
**60V N-Channel Enhancement Mode Power MOSFET**

**Package Mechanical Data TO-252**



Ref.	Dimensions					
	Millimeters			Inches		
	Min.	Typ.	Max.	Min.	Typ.	Max.
A	2.10		2.50	0.083		0.098
A2	0		0.10	0		0.004
B	0.66		0.86	0.026		0.034
B2	5.18		5.48	0.202		0.216
C	0.40		0.60	0.016		0.024
C2	0.44		0.58	0.017		0.023
D	5.90		6.30	0.232		0.248
D1	5.30REF			0.209REF		
E	6.40		6.80	0.252		0.268
E1	4.63			0.182		
G	4.47		4.67	0.176		0.184
H	9.50		10.70	0.374		0.421
L	1.09		1.21	0.043		0.048
L2	1.35		1.65	0.053		0.065
V1		7°			7°	
V2	0°		6°	0°		6°

**Marking**



**Ordering information**

Order code	Package	Baseqty	Deliverymode
IRLR2905TR	TO-252	2500	Tape and reel