

### General Description

The SN74LVC1G32 is a single 2-input OR Gate in three tiny footprint packages. The device performs much as LCX multi-gate products in speed and drive.

### Features

- Tiny SC70-5 /SOT23-5 Packages
- 2.4ns  $t_{PD}$  at 5V (typ)
- Source/Sink 24mA at 3.0V
- Over-Voltage Tolerant Inputs
- Designed for 1.65V to 5.5V  $V_{CC}$  Operation
- These Devices are Pb-Free and are RoHS Compliant

### Pin Configuration

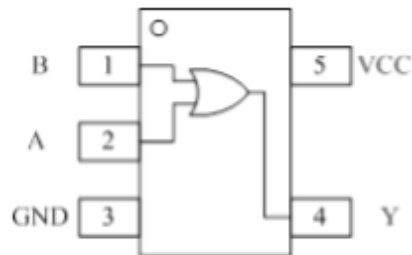

SC70-5/SOT23-5

Figure1: Top View

**Pin Function**

(SC70 -5/ SOT23-5)

PIN	FUNCTION
1	IN B
2	INA
3	GND
4	Y
5	VCC

**Block Diagram**

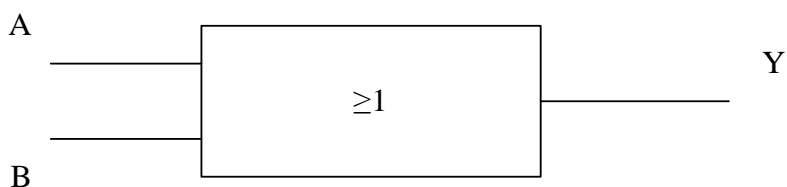

Figure2.Logic symbol

**Functional Description**

**Function Table**

Input		Output
A	B	Y
L	L	L
L	H	H
H	L	H
H	H	H

**Absolute Maximum Ratings**

Symbol	Parameter	Value	Unit
V <sub>CC</sub>	DC Supply Voltage	-0.5 to 7.0	V
V <sub>I</sub>	DC Input Voltage	-0.5 ≤ V <sub>I</sub> ≤ +7.0	V
V <sub>O</sub>	DC Output Voltage Output in Higher or Low State	-0.5 to V <sub>CC</sub> + 0.5	V
I <sub>IK</sub>	DC Input Diode Current V <sub>I</sub> < GND	-50	mA
I <sub>OK</sub>	DC Output Diode Current V <sub>O</sub> < GND, V <sub>O</sub> > V <sub>CC</sub>	±50	mA
I <sub>O</sub>	DC Output Sink Current	±50	mA
I <sub>CC</sub>	DC Supply Current per Supply Pin	±100	mA
I <sub>GND</sub>	DC Ground Current per Supply Pin	±100	mA
T <sub>STG</sub>	Storage Temperature Range	-65 to 150	°C
T <sub>L</sub>	Lead Temperature, 1 mm from Case for 10 Seconds	260	°C
T <sub>J</sub>	Junction Temperature Under Bias	150	°C
θ <sub>JA</sub>	Thermal Resistance SC70-5 SOT23-5	435	°C/W
		300	
		423	
P <sub>D</sub>	Power Dissipation in Still Air at 85°C	200	mW
MSL	Moisture Sensitivity	Level 1	
ESD	ESD Classification Human Body Model (Note 2)	2000	V
	Machine Model (Note 3)	200	
	Charged Device Model (Note 4)	N/A	
I <sub>Latchup</sub>	Latchup Performance Above V <sub>CC</sub> and Below GND at 125°C (Note 5)	±100	mA

Stresses exceeding those listed in the Maximum Ratings table may damage the device. If any of these limits are exceeded, device functionality should not be assumed, damage may occur and reliability may be affected.

1. IO absolute maximum rating must be observed.
2. Tested to EIA/JESD22-A114-A, rated to EIA/JESD22-A114-B.
3. Tested to EIA/JESD22-A115-A, rated to EIA/JESD22-A115-A.
4. Tested to JESD22-C101-A.
5. Tested to EIA/JESD78

**Recommended Operating Conditions**

Symbol	Parameter	Min	Max	Unit
V <sub>CC</sub>	DC Supply Voltage Operating	1.65	5.5	V
	Date Retention	1.5	5.5	
V <sub>IN</sub>	DC Input Voltage	0	5.5	V
V <sub>OUT</sub>	DC Output Voltage (High or Low State)	0	5.5	V
T <sub>A</sub>	Operating Temperature Range	-40	85	°C
t <sub>r</sub> , t <sub>f</sub>	Input Rise and Fall Time V <sub>CC</sub> = 2.5 V ± 0.2 V	0	20	ns/V
	V <sub>CC</sub> = 3.0 V ± 0.3 V	0	10	
	V <sub>CC</sub> = 5.0 V ± 0.5 V	0	5	

**Electrical Characteristics**
**DC ELECTRICAL CHARACTERISTICS**

Symbol	Parameter	Condition	V <sub>CC</sub> (V)	TA = 25 °C			-40 °C ≤ TA ≤ 85 °C		Unit
				Min	Typ	Max	Min	Max	
V <sub>IH</sub>	High-Level Input Voltage		1.65 to 1.95 2.3 to 5.5	0.75V <sub>CC</sub> 0.7V <sub>CC</sub>			0.75V <sub>CC</sub> 0.7V <sub>CC</sub>		V
V <sub>IL</sub>	Low-Level Input Voltage		1.65 to 1.95 2.3 to 5.5			0.25V <sub>CC</sub> 0.3V <sub>CC</sub>		0.25V <sub>CC</sub> 0.3V <sub>CC</sub>	V
V <sub>OH</sub>	High-Level Output Voltage V <sub>IN</sub> = V <sub>IL</sub>	I <sub>OH</sub> = -100µA	1.65 to 5.5	V <sub>CC</sub> - 0.1	V <sub>CC</sub>		V <sub>CC</sub> - 0.1		V
		I <sub>OH</sub> = -3mA	1.65	1.29	1.52		1.29		
		I <sub>OH</sub> = -8mA	2.3	1.9	2.1		1.9		
		I <sub>OH</sub> = -12mA	2.7	2.2	2.4		2.2		
		I <sub>OH</sub> = -16mA	3.0	2.4	2.7		2.4		
		I <sub>OH</sub> = -24mA	3.0	2.3	2.5		2.3		
		I <sub>OH</sub> = -32mA	4.5	3.8	4.0		3.8		
V <sub>OL</sub>	Low-Level Output Voltage V <sub>IN</sub> = V <sub>IH</sub>	I <sub>OH</sub> = 100µA	1.65 to 5.5		0.0	0.1		0.1	V
		I <sub>OL</sub> = 3mA	1.65		0.08	0.24		0.24	
		I <sub>OL</sub> = 8mA	2.3		0.20	0.3		0.3	
		I <sub>OL</sub> = 12mA	2.7		0.22	0.4		0.4	
		I <sub>OL</sub> = 16mA	3.0		0.28	0.4		0.4	
		I <sub>OL</sub> = 24mA	3.0		0.38	0.55		0.55	
		I <sub>OL</sub> = 32mA	4.5		0.42	0.55		0.55	
I <sub>IN</sub>	Input Leakage Current	V <sub>IN</sub> = 5.5V or GND	0 to 5.5		±0.1			±1.0	µA
I <sub>OFF</sub>	Power Off Leakage Current	V <sub>IN</sub> = 5.5V or V <sub>OUT</sub> = 5.5V	0			1		10	µA
I <sub>CC</sub>	Quiescent Supply Current	V <sub>IN</sub> = 5.5V or GND	5.5					10	µA

Product parametric performance is indicated in the Electrical Characteristics for the listed test conditions, unless otherwise noted. Product performance may not be indicated by the Electrical Characteristics if operated under different conditions.

**AC ELECTRICAL CHARACTERISTICS**

$t_r=t_f=3\text{ns}$ ;

Symbol	Parameter	Condition	$V_{CC}(V)$	TA = 25 °C			-40°C ≤TA≤85°C		Unit
				Min	Typ	Max	Min	Max	
$t_{PD}$	Propagation Delay (Figure3and4)	$R_L=1\text{M}\Omega$ $C_L=15\text{pF}$	1.65	2.0	10.1	12.9	2.0	13.9	ns
			1.8	2.0	9.1	11.6	2.0	12.4	
		$R_L=1\text{M}\Omega$ $C_L=15\text{pF}$	2.5	0.2	6.0	7.7	0.8	8.2	
			3.3	$R_L=1\text{M}\Omega$ $C_L=15\text{pF}$	0.8	5.0	6.5	0.5	
		$R_L=500\Omega$ $C_L=50\text{pF}$		1.2	5.6	7.1	1.5	7.6	
		5.0	$R_L=1\text{M}\Omega$ $C_L=15\text{pF}$	0.5	4.4	5.6	0.5	6.1	
$R_L=500\Omega$ $C_L=50\text{pF}$	0.8		4.8	6.1	0.8	6.6			

**CAPACITIVE CHARACTERISTICS**

Symbol	Parameter	Condition	Typical	Unit
$C_{IN}$	Input Capacitance	$V_{CC}=5.5\text{V}$ , $V_I=0\text{V}$ or $V_{CC}$	>2.5	pF
$C_{PD}$	Power Dissipation Capacitance (Note 6)	10MHz, $V_{CC}=3.3\text{V}$ , $V_I=0\text{V}$ or $V_{CC}$	21	pF
		10MHz, $V_{CC}=5.5\text{V}$ , $V_I=0\text{V}$ or $V_{CC}$	21	

6.  $C_{PD}$  is defined as the value of the internal equivalent capacitance which is calculated from the operating current consumption without load. Average operating current can be obtained by the equation:

$I_{CC(OPR)}=C_{PD} \cdot V_{CC} \cdot f_{in} + I_{CC} \cdot C_{PD}$  is used to determine the no-load dynamic power consumption;

$P_D=C_{PD} \cdot V_{CC}^2 \cdot f_{in} + I_{CC} \cdot V_{CC} \cdot Fig.$

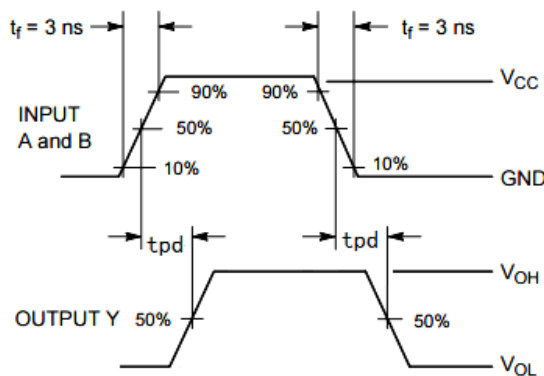
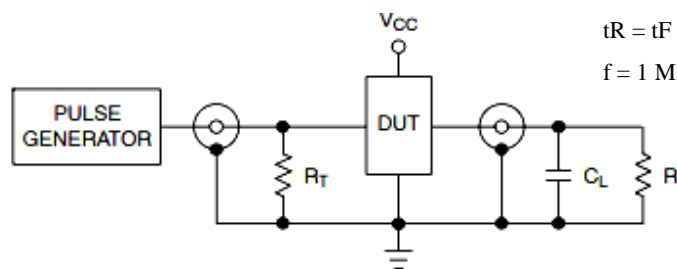

**Figure 3. Switching Waveform**

PROPAGATION DELAYS

$t_r = t_f = 3\text{ns}$ , 10% to 90%;

$f = 1\text{MHz}$ ;  $t_W = 500\text{ns}$



**Figure 4. Test Circuit**

**Package Dimension**

**SC70-5**

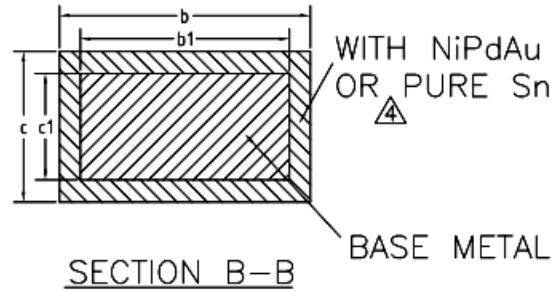
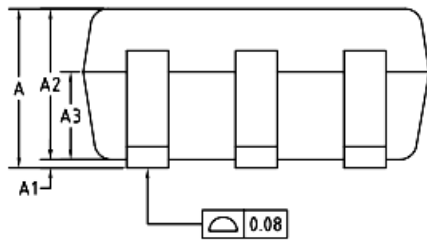
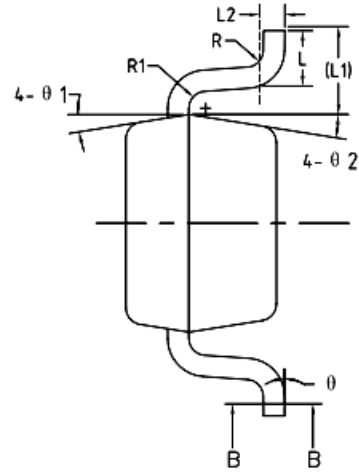
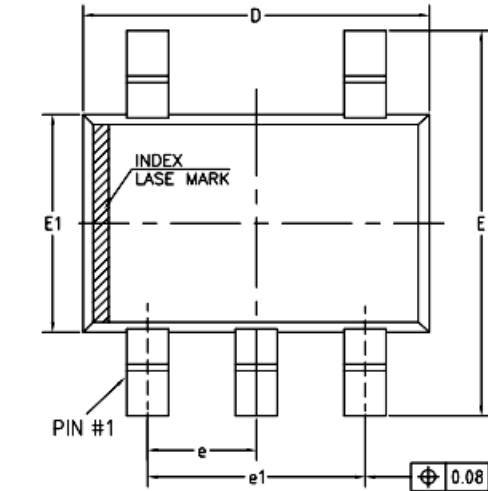

COMMON DIMENSIONS  
(UNITS OF MEASURE=MILLIMETER)

SYMBOL	MIN	NOM	MAX	
A	0.85	—	1.05	
A1	0	—	0.10	
A2	0.80	0.90	1.00	
A3	0.47	0.52	0.57	
b	NiPdAu	0.22	—	0.29
	PURE Sn	0.23	—	0.33
b1	0.22	0.25	0.28	
c	NiPdAu	0.115	—	0.15
	PURE Sn	0.12	—	0.18
c1	0.115	0.13	0.14	
D	2.02	2.07	2.12	
E	2.20	2.30	2.40	
E1	1.25	1.30	1.35	
e	0.60	0.65	0.70	
e1	1.20	1.30	1.40	
L	0.28	0.33	0.38	
L1	0.50REF			
L2	0.15BSC			
R	0.10	—	—	
R1	0.10	—	0.25	
θ	0°	—	8°	
θ 1	6°	9°	12°	
θ 2	6°	9°	12°	

**SOT23-5**

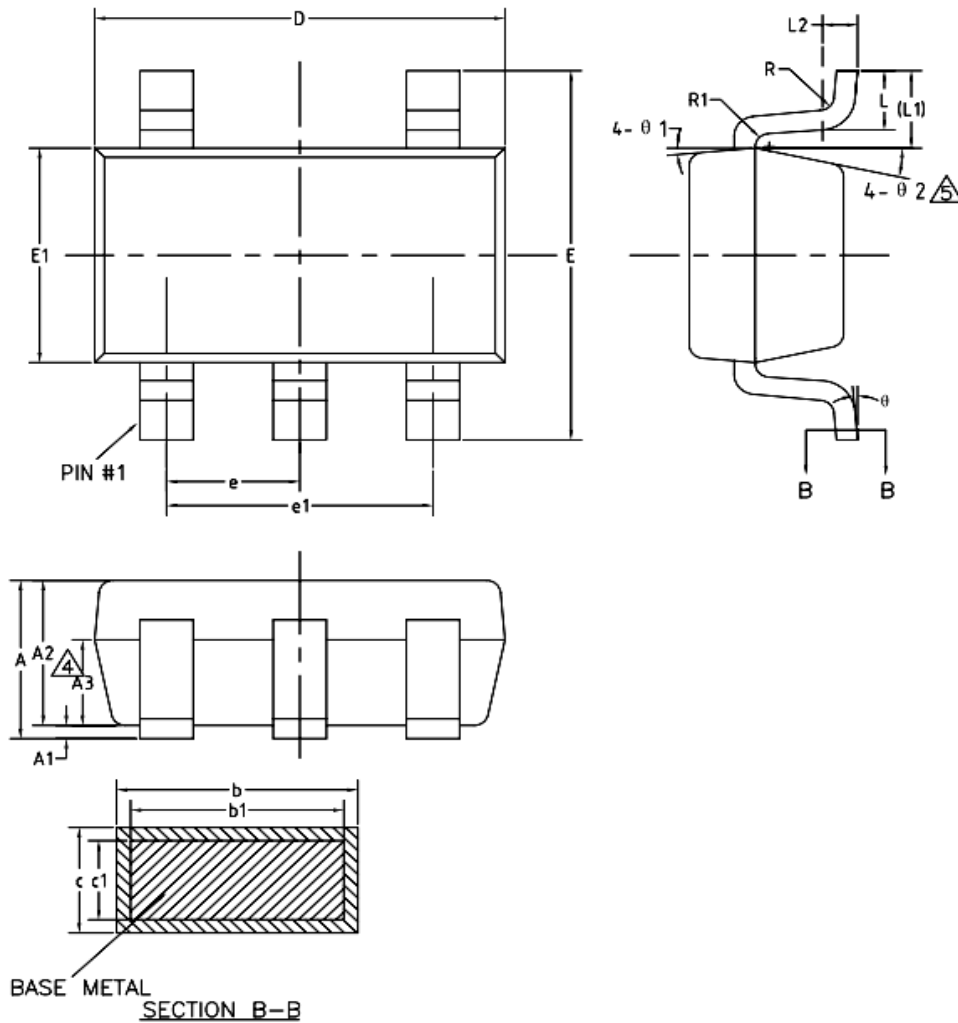

COMMON DIMENSIONS  
(UNITS OF MEASURE=MILLIMETER)

SYMBOL	MIN	NOM	MAX
A	—	—	1.25
$\triangle$ A1	0	—	0.15
A2	1.00	1.10	1.20
A3	0.60	0.65	0.70
b	0.36	—	0.50
b1	0.36	0.38	0.45
c	0.14	—	0.20
c1	0.14	0.15	0.16
D	2.826	2.926	3.026
E	2.60	2.80	3.00
E1	1.526	1.626	1.726
$\triangle$ e	0.90	0.95	1.00
$\triangle$ e1	1.80	1.90	2.00
L	0.35	0.45	0.60
L1	0.59REF		
L2	0.25BSC		
R	0.10	—	—
R1	0.10	—	0.25
$\theta$	0°	—	8°
$\theta$ 1	3°	5°	7°
$\triangle$ $\theta$ 2	6°	—	14°

**Ordering information**

<b>Order code</b>	<b>Marking code</b>	<b>Package</b>	<b>Baseqty</b>	<b>Deliverymode</b>
SN74LVC1G32DBVR	C32R	SOT23-5	3000	Tape and reel
SN74LVC1G32DCKR	CG5	SC70-5	3000	Tape and reel