

Product introduction

SN74LVC1G08 is a 2-input AND gate integrated circuit, which can realize the mathematical logic operation of $Y = A \cdot B$ and $Y = \overline{A + B}$. Advanced CMOS process design is adopted, which has the working characteristics of low power consumption and high output driving capability. The chip can work normally when the power supply voltage VCC is between 1.65V and 5.5V V. And 74LVC1G08 has a variety of small package shapes, It can be widely used in high-end precision instruments, miniaturized low-power handheld devices, artificial intelligence and other fields.

Product features

- Low input current: 0.1uA typical
- Low static power consumption: 0.1uA typical
- High output drive: VCC=4.5V, more than 32MA
- Wide working voltage range: 1.65V to 5.5V
- Package form: DBV/DCK/DRL/YZP/ DRY/DSF/ DPW

product usage

- Portable audio interface
- digital television
- Wireless headphones, smart watches, etc.
- Blu-ray player and home theater
- Solid state drive
- Smart wearable devices

Package form and pin function definition

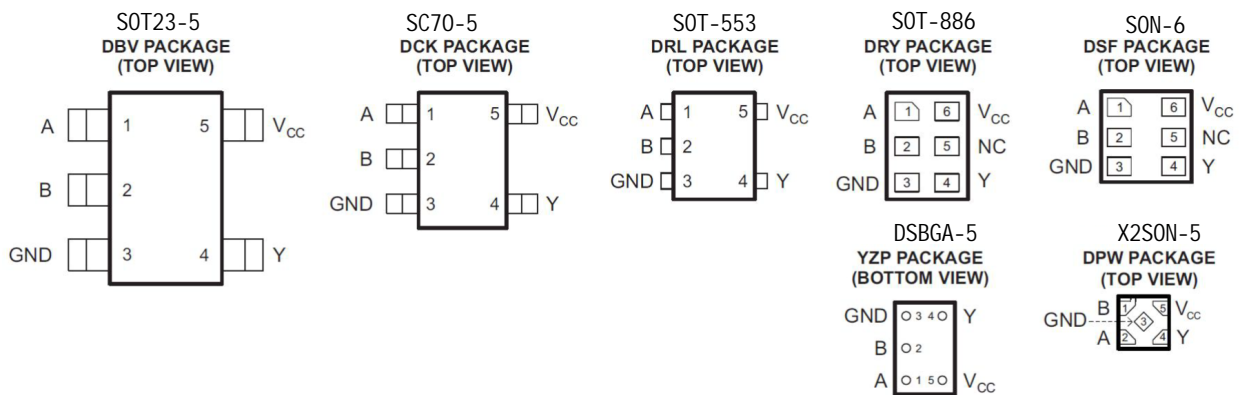

| NAME | PIN | | | DESCRIPTION |
|-----------------|--------------------|----------|-----|---------------|
| | DBV, DCK, DRL, YZP | DRY, DSF | DPW | |
| A | 1 | 1 | 2 | Input |
| B | 2 | 2 | 1 | Input |
| GND | 3 | 3 | 3 | Ground |
| Y | 4 | 4 | 4 | Output |
| V _{CC} | 5 | 6 | 5 | Power pin |
| NC | | 5 | | Not connected |

Note: NC null pin, no connecting wire inside.

■ Limit parameter

| parameter | symbol | limit value | unit |
|---------------------------|-----------|-------------|------|
| operating voltage | V_{CC} | 6.5 | V |
| input | V_{IN} | -0.5~6.5 | V |
| Output voltage (1) | V_{OUT} | -0.5~6.5 | V |
| Single pin output current | I_{OUT} | 25 | mA |
| Or Vcc current. | I_{CC} | 50 | mA |
| Storage temperature | T_S | -65-150 | °C |
| Pin welding temperature | T_W | 260, 10s | °C |
| Working temperature | T_A | -40-105 | °C |

Note: 1. Under the condition of $V_{CC} = 0V$ power-off, the output can withstand the limit voltage,

2. Limit parameter refers to the limit value that cannot be exceeded under any condition. In case of exceeding this limit value, physical properties such as product degradation may be caused Damage;

At the same time, the chip can not be guaranteed to work normally under the near limit parameters.

■ Principle logic diagram

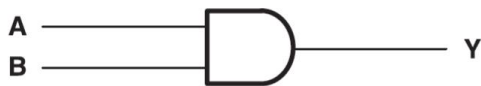

■ truth table

| Inputs | | Output |
|--------|---|--------|
| A | B | Y |
| L | L | L |
| L | H | L |
| H | L | L |
| H | H | H |

■ working conditions

| project | symbol | test condition | minimum value | typical value | maximum | unit |
|---------------------------|----------|-----------------------------|-----------------|---------------|-----------------|------|
| operating voltage | V_{CC} | - | 1.65 | - | 5.5 | V |
| Input high level voltage | V_{IH} | $V_{CC} = 1.65V \sim 1.95V$ | $0.65 * V_{CC}$ | - | - | V |
| | | $V_{CC} = 2.3V \sim 2.7V$ | 1.7V | - | - | |
| | | $V_{CC} = 3V \sim 5.5V$ | $0.7 * V_{CC}$ | - | - | |
| Low-Level Input Voltage | V_{IL} | $V_{CC} = 1.65V \sim 1.95V$ | - | - | $0.35 * V_{CC}$ | V |
| | | $V_{CC} = 2.3V \sim 2.7V$ | - | - | 0.7 | |
| | | $V_{CC} = 3V \sim 5.5V$ | - | - | $0.3 * V_{CC}$ | |
| input voltage | V_I | - | 0 | - | 5.5 | V |
| Output voltage | V_O | - | 0 | - | V_{CC} | V |
| High level output current | I_{OH} | $V_{CC} = 1.65V$ | - | - | -4 | mA |
| | | $V_{CC} = 2.3V$ | - | - | -8 | |
| | | $V_{CC} = 3V$ | - | - | -16 | |
| | | $V_{CC} = 4.5V$ | - | - | -32 | |
| Low level output current | I_{OL} | $V_{CC} = 1.65V$ | - | - | 4 | mA |
| | | $V_{CC} = 2.3V$ | - | - | 8 | |
| | | $V_{CC} = 3V$ | - | - | 16 | |
| | | $V_{CC} = 4.5V$ | - | - | 32 | |

■ **Electrical characteristics**

Electrical characteristics of DC: $T_A=25^{\circ}\text{C}$

| project | symbol | test condition | V_{CC} | typical value | maximum | unit |
|---------------------------------|-----------------|---|---------------------|---------------|----------|------|
| High level load voltage | V_{OH} | $I_{OH}=-100\mu\text{A}$ | 1.65V~5.5V | 1.64 | - | V |
| | | $I_{OH}=-4\text{ mA}$ | 1.65V | 1.47 | - | |
| | | $I_{OH}=-8\text{ mA}$ | 2.3V | 2.15 | - | |
| | | $I_{OH}=-16\text{ mA}$ | 3V | 2.73 | - | |
| | | $I_{OH}=-32\text{ mA}$ | 4.5V | 4.0 | - | |
| Low level load voltage | V_{OL} | $I_{OH}=100\mu\text{A}$ | 1.65V~5.5V | 0.01 | - | V |
| | | $I_{OH}=4\text{ mA}$ | 1.65V | 0.11 | - | |
| | | $I_{OH}=8\text{ mA}$ | 2.3V | 0.11 | - | |
| | | $I_{OH}=16\text{ mA}$ | 3V | 0.2 | - | |
| | | $I_{OH}=32\text{ mA}$ | 4.5V | 0.35 | - | |
| incoming current | I_I | A B $V_I=5.5\text{V}$ or GND | $0\sim 5.5\text{V}$ | 0.01 | ± 5 | uA |
| | | | | 0.01 | ± 5 | |
| Turn-off current | I_{OFF} | $V_I=5.5\text{V}$ | 0 | 0.01 | ± 10 | uA |
| | | $V_O=5.5\text{V}$ | 0 | 0.01 | ± 10 | |
| operational current | I_{CC} | $V_I=5.5\text{V}, I_O=0$ | 1.65V~5.5V | 0.01 | 10 | uA |
| | | $V_I=\text{GND}, I_O=0$ | | 0.01 | 10 | |
| Working current variation value | ΔI_{CC} | A= $V_{CC}-0.6\text{V}$ B= V_{CC} or GND | 3V~5.5V | 25 | - | uA |
| | | B= $V_{CC}-0.6\text{V}$ A= VCC or GND | | 25 | - | |

Ac electrical characteristics: $T_A=25^{\circ}\text{C}$ $V(298)=5.0\text{V}$, $t_r \leq 20\text{ns}$. See test method.

| project | symbol | test condition | minimum value | typical value | maximum | unit |
|---|-----------|-------------------|---------------|---------------|---------|------|
| Maximum transmission delay time a, B to Y | t_{PHL} | $C_L=15\text{pF}$ | - | 10 | - | ns |
| | t_{PLH} | $C_L=15\text{pF}$ | - | 10 | - | ns |

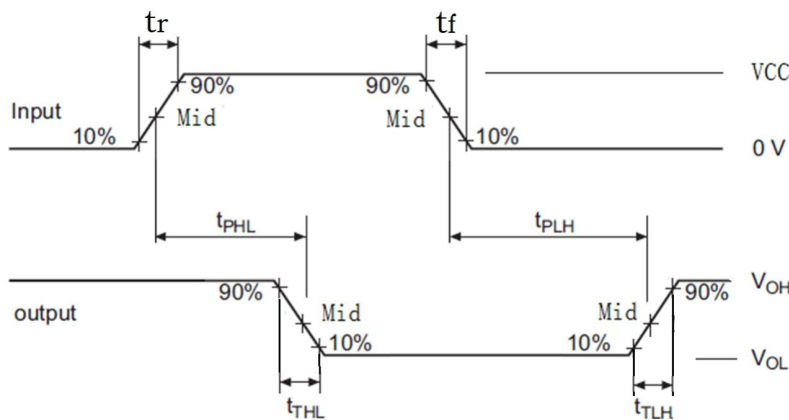

Note: 1. C_L capacitor is external chip capacitor (0603), which is connected close to the output pin, and the capacitor ground is close to the chip GND; 2. Input: port input level, $f=500\text{kHz}$, $D=50\%$; $t_r=t_f \leq 20\text{ns}$; 3. Output: Y-terminal output test.

■ Encapsulated information

Unit: mm/inch

DBV (SOT23-5)

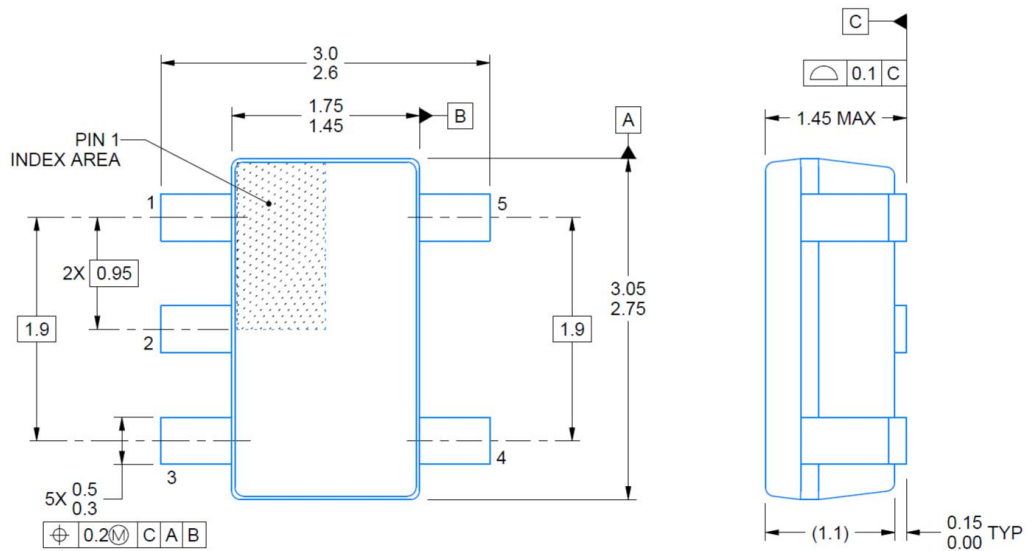

■ Marking

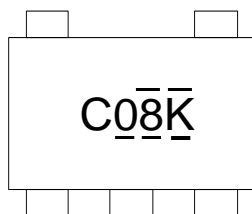

DCK (SC70-5)

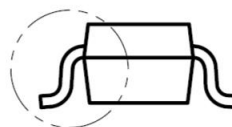
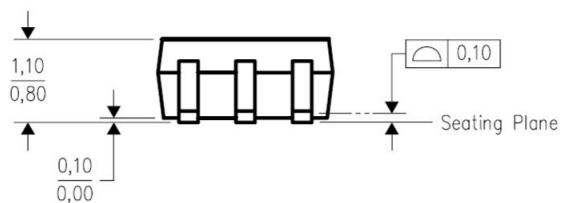
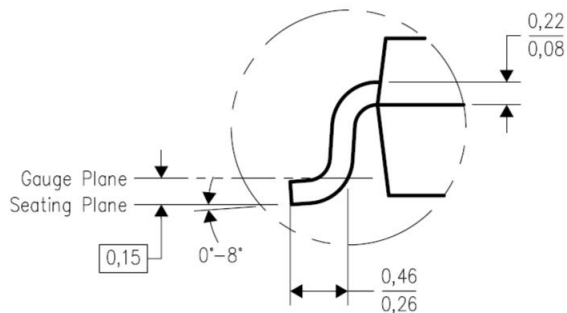
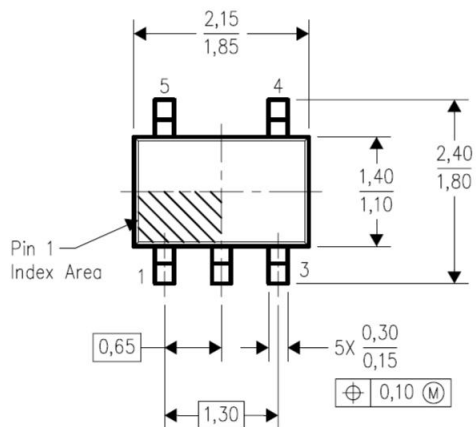

■ **Marking**

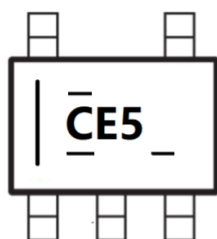

DRL (SOT-553)

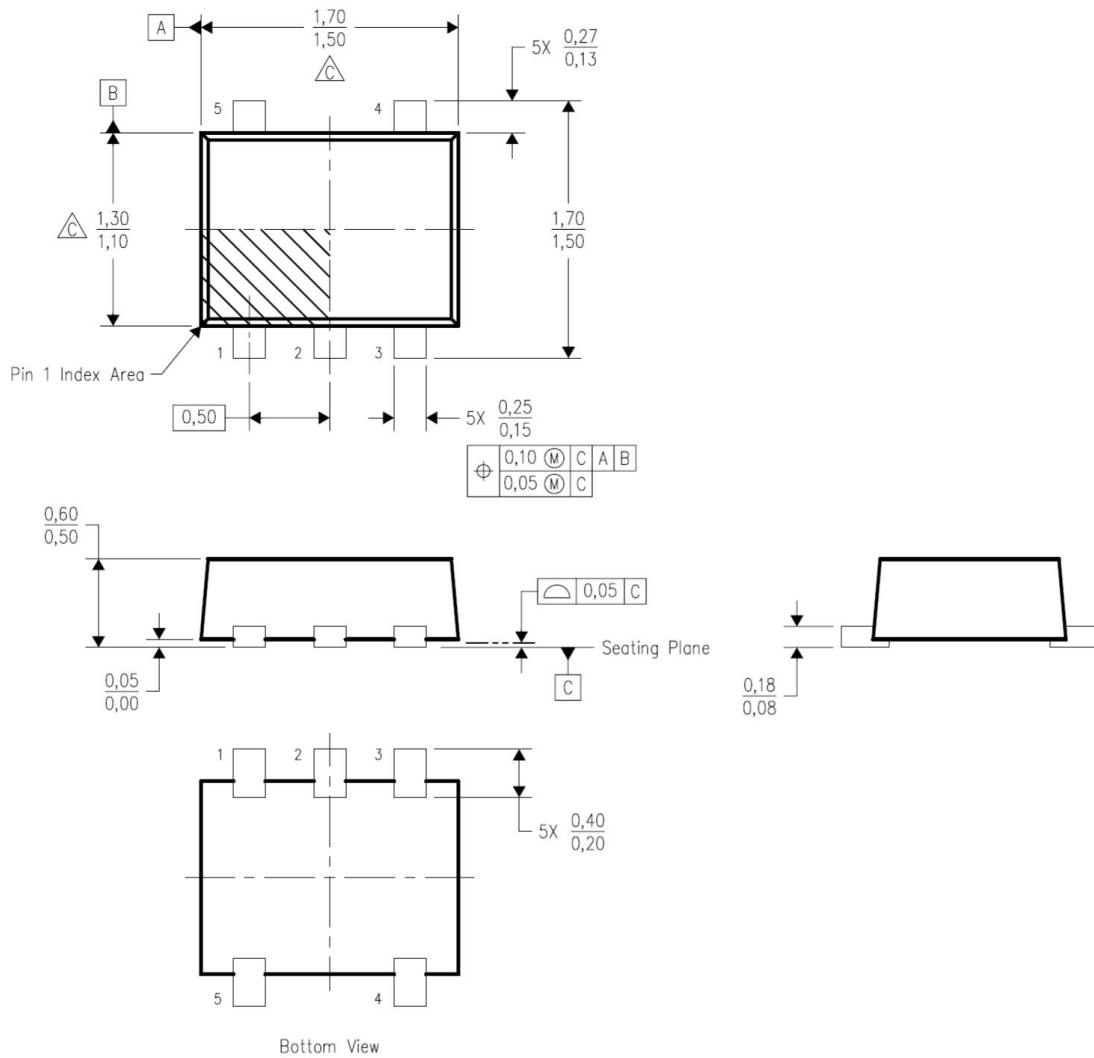

DRY (SOT-886)

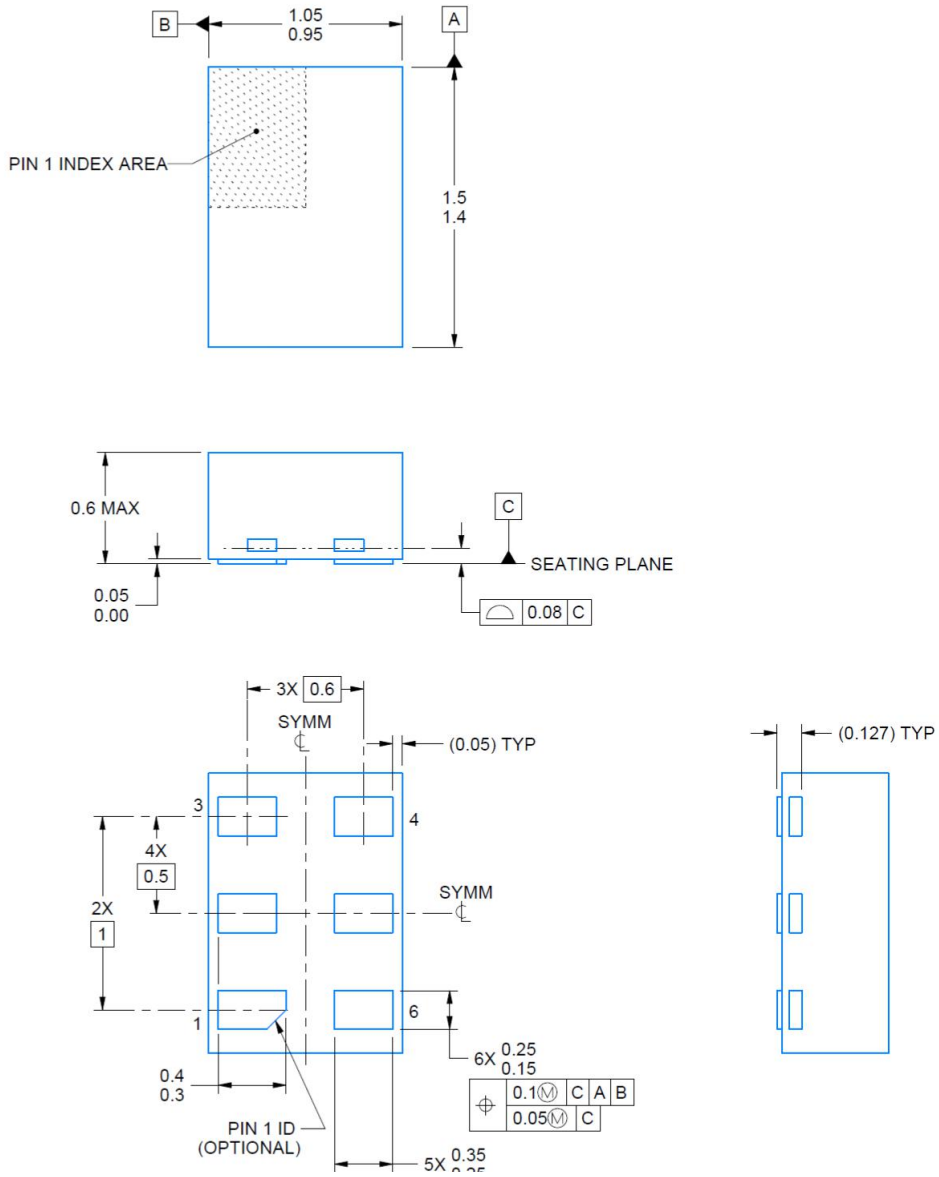

DSF (SON-6)

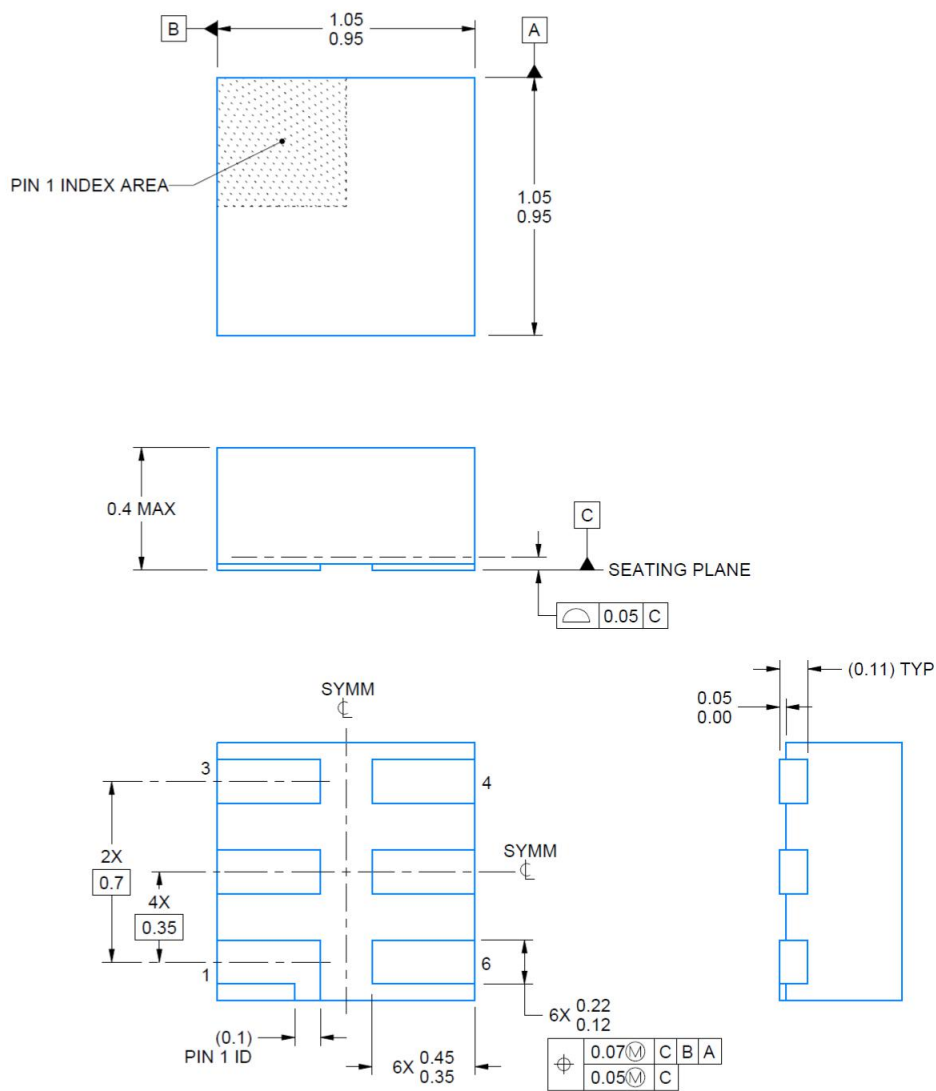

YZP (DSBGA-5)

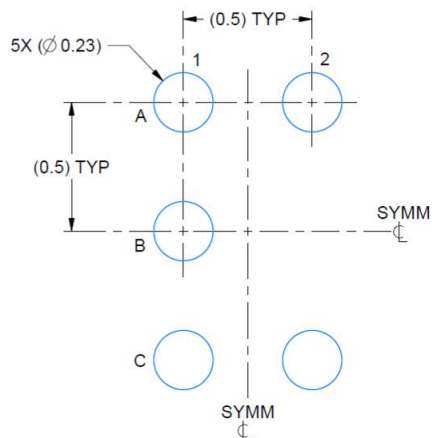

LAND PATTERN EXAMPLE
SCALE:40X

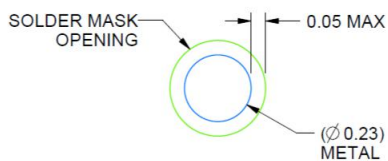

NON-SOLDER MASK
DEFINED
(PREFERRED)

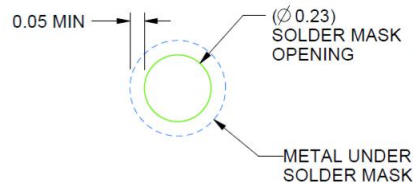

SOLDER MASK
DEFINED

DPW (X2SON-5)

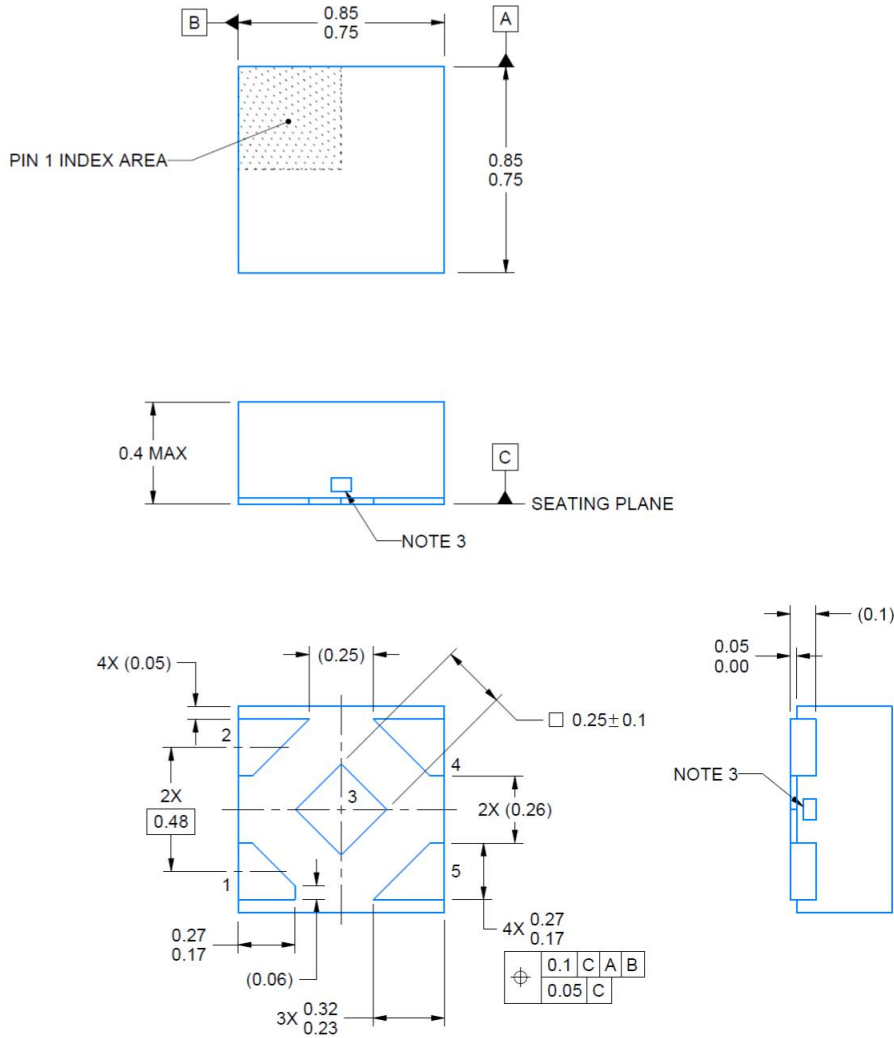

Ordering information

| Order code | Package | Baseqty | Deliverymode |
|-----------------|---------|---------|---------------|
| SN74LVC1G08DBVR | SOT23-5 | 3000 | Tape and reel |
| SN74LVC1G08DCKR | SC70-5 | 3000 | Tape and reel |
| SN74LVC1G08DSFR | SON-6 | 5000 | Tape and reel |
| SN74LVC1G08DRYR | SOT-886 | 5000 | Tape and reel |
| SN74LVC1G08YZPR | DSBGA-5 | 3000 | Tape and reel |
| SN74LVC1G08DPWR | X2SON-5 | 3000 | Tape and reel |
| SN74LVC1G08DRLR | SOT-553 | 4000 | Tape and reel |