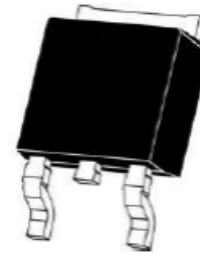


**Features**

- $V_{DS} (V) = 30V$
- $R_{DS(ON)} < 5.8m\Omega$  ( $V_{GS} = 10V$ )
- $R_{DS(ON)} < 8 m\Omega$  ( $V_{GS} = 4.5V$ )

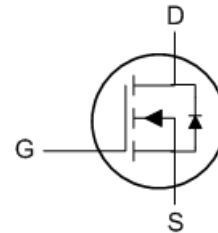
**Applications**

- High Frequency Synchronous Buck Converters for Computer Processor Power
- High Frequency Isolated DC-DC Converters with Synchronous Rectification for Telecom and Industrial Use



**Benefits**

- Very Low  $R_{DS(on)}$  at 4.5V  $V_{GS}$
- Ultra-Low Gate Impedance
- Fully Characterized Avalanche Voltage and Current



**Absolute Maximum Ratings**

	Parameter	Max.	Units
$V_{DS}$	Drain-to-Source Voltage	30	V
$V_{GS}$	Gate-to-Source Voltage	$\pm 20$	
$I_D @ T_C = 25^\circ C$	Continuous Drain Current, $V_{GS} @ 10V$	86 <sup>④</sup>	A
$I_D @ T_C = 100^\circ C$	Continuous Drain Current, $V_{GS} @ 10V$	61 <sup>④</sup>	
$I_{DM}$	Pulsed Drain Current <sup>①</sup>	340	
$P_D @ T_C = 25^\circ C$	Maximum Power Dissipation <sup>⑥</sup>	75	W
$P_D @ T_C = 100^\circ C$	Maximum Power Dissipation <sup>⑥</sup>	38	
	Linear Derating Factor	0.5	W/ $^\circ C$
$T_J$	Operating Junction and	-55 to + 175	$^\circ C$
$T_{STG}$	Storage Temperature Range		
	Soldering Temperature, for 10 seconds	300 (1.6mm from case)	

**Thermal Resistance**

	Parameter	Typ.	Max.	Units
$R_{\theta JC}$	Junction-to-Case <sup>⑥</sup>		2.0	$^\circ C/W$
$R_{\theta JA}$	Junction-to-Ambient (PCB Mount) <sup>⑤</sup>		50	
$R_{\theta JA}$	Junction-to-Ambient		110	

**Notes**

- ① Repetitive rating; pulse width limited by max. junction temperature.
- ② Starting  $T_J = 25^\circ C$ ,  $L = 0.605mH$ ,  $R_G = 25\Omega$ ,  $I_{AS} = 20A$ .
- ③ Pulse width  $\leq 400\mu s$ ; duty cycle  $\leq 2\%$ .
- ④ Calculated continuous current based on maximum allowable junction temperature. Package limitation current is 50A.
- ⑤ When mounted on 1" square PCB (FR-4 or G-10 Material). For recommended footprint and soldering techniques refer to application note #AN-994.
- ⑥  $R_{\theta}$  is measured at  $T_J$  approximately at  $90^\circ C$

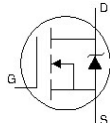
**Static @ T<sub>J</sub> = 25°C (unless otherwise specified)**

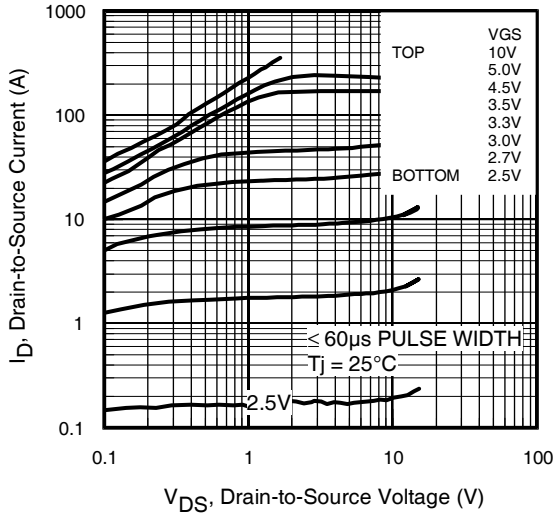
	Parameter	Min.	Typ.	Max.	Units	Conditions
BV <sub>DSS</sub>	Drain-to-Source Breakdown Voltage	30			V	V <sub>GS</sub> = 0V, I <sub>D</sub> = 250μA
ΔBV <sub>DSS</sub> /ΔT <sub>J</sub>	Breakdown Voltage Temp. Coefficient		20		mV/°C	Reference to 25°C, I <sub>D</sub> = 1mA
R <sub>DS(on)</sub>	Static Drain-to-Source On-Resistance		4.0	5.8	mΩ	V <sub>GS</sub> = 10V, I <sub>D</sub> = 25A ③
			5.8	8.0		V <sub>GS</sub> = 4.5V, I <sub>D</sub> = 20A ③
V <sub>GS(th)</sub>	Gate Threshold Voltage	1.35	1.80	2.35	V	V <sub>DS</sub> = V <sub>GS</sub> , I <sub>D</sub> = 50μA
ΔV <sub>GS(th)</sub> /ΔT <sub>J</sub>	Gate Threshold Voltage Coefficient		-8.6		mV/°C	
I <sub>DSS</sub>	Drain-to-Source Leakage Current			1.0	μA	V <sub>DS</sub> = 24V, V <sub>GS</sub> = 0V
				150		V <sub>DS</sub> = 24V, V <sub>GS</sub> = 0V, T <sub>J</sub> = 125°C
I <sub>GSS</sub>	Gate-to-Source Forward Leakage			100	nA	V <sub>GS</sub> = 20V
	Gate-to-Source Reverse Leakage			-100		V <sub>GS</sub> = -20V
g <sub>fs</sub>	Forward Transconductance	73			S	V <sub>DS</sub> = 15V, I <sub>D</sub> = 20A
Q <sub>g</sub>	Total Gate Charge		15	23		V <sub>DS</sub> = 15V V <sub>GS</sub> = 4.5V I <sub>D</sub> = 20A See Fig. 15
Q <sub>gs1</sub>	Pre-V <sub>th</sub> Gate-to-Source Charge		3.7			
Q <sub>gs2</sub>	Post-V <sub>th</sub> Gate-to-Source Charge		1.9			
Q <sub>gd</sub>	Gate-to-Drain Charge		5.7			
Q <sub>godr</sub>	Gate Charge Overdrive		3.7			
Q <sub>sw</sub>	Switch Charge (Q <sub>gs2</sub> + Q <sub>gd</sub> )		7.6			
Q <sub>oss</sub>	Output Charge		10		nC	V <sub>DS</sub> = 15V, V <sub>GS</sub> = 0V
R <sub>G</sub>	Gate Resistance		2.0	3.5	Ω	
t <sub>d(on)</sub>	Turn-On Delay Time		12			V <sub>DD</sub> = 15V, V <sub>GS</sub> = 4.5V ③ I <sub>D</sub> = 20A R <sub>G</sub> = 1.8Ω See Fig. 13
t <sub>r</sub>	Rise Time		49			
t <sub>d(off)</sub>	Turn-Off Delay Time		15		ns	
t <sub>f</sub>	Fall Time		16			
C <sub>iss</sub>	Input Capacitance		2150			V <sub>GS</sub> = 0V V <sub>DS</sub> = 15V f = 1.0MHz
C <sub>oss</sub>	Output Capacitance		480		pF	
C <sub>rss</sub>	Reverse Transfer Capacitance		205			

**Avalanche Characteristics**

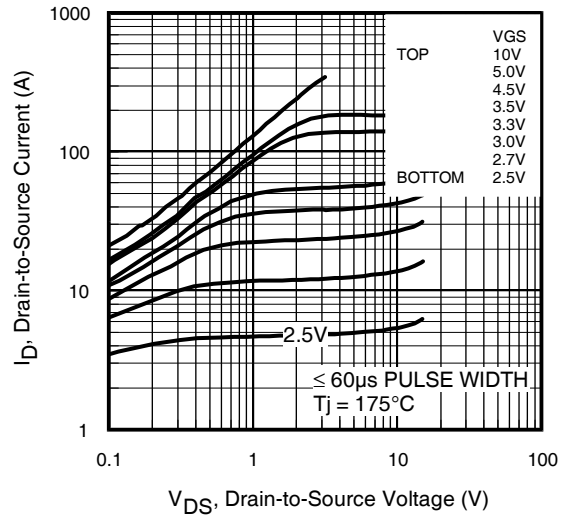
	Parameter	Typ.	Max.	Units
E <sub>AS</sub>	Single Pulse Avalanche Energy ②		120	mJ
I <sub>AR</sub>	Avalanche Current ①		20	A

**Diode Characteristics**

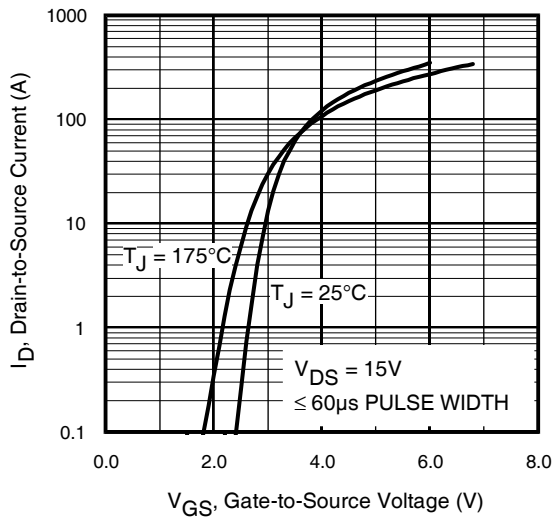
	Parameter	Min.	Typ.	Max.	Units	Conditions
I <sub>S</sub>	Continuous Source Current (Body Diode)			86 ④	A	MOSFET symbol showing the integral reverse p-n junction diode. 
I <sub>SM</sub>	Pulsed Source Current (Body Diode) ①			340		
V <sub>SD</sub>	Diode Forward Voltage			1.0	V	T <sub>J</sub> = 25°C, I <sub>S</sub> = 20A, V <sub>GS</sub> = 0V ③
t <sub>rr</sub>	Reverse Recovery Time		24	36	ns	T <sub>J</sub> = 25°C, I <sub>F</sub> = 20A, V <sub>DD</sub> = 15V
Q <sub>rr</sub>	Reverse Recovery Charge		52	78	nC	di/dt = 300A/μs ③



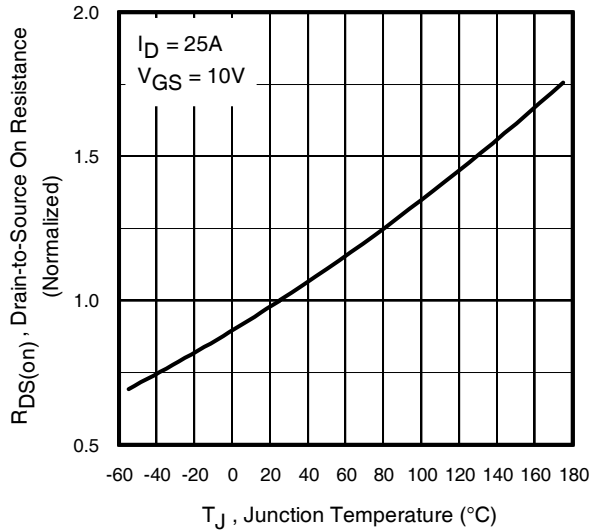
**Fig 1.** Typical Output Characteristics



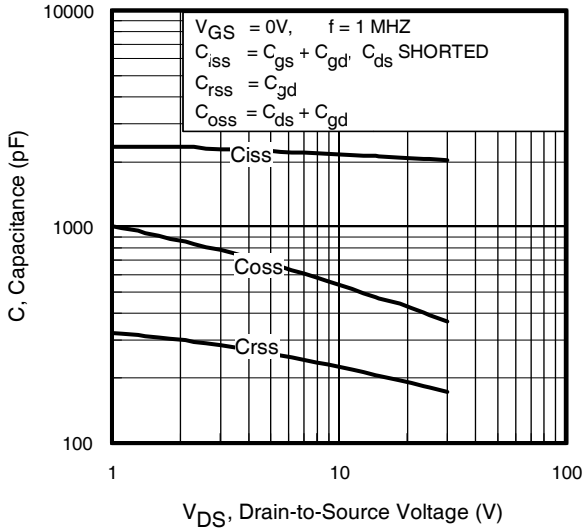
**Fig 2.** Typical Output Characteristics



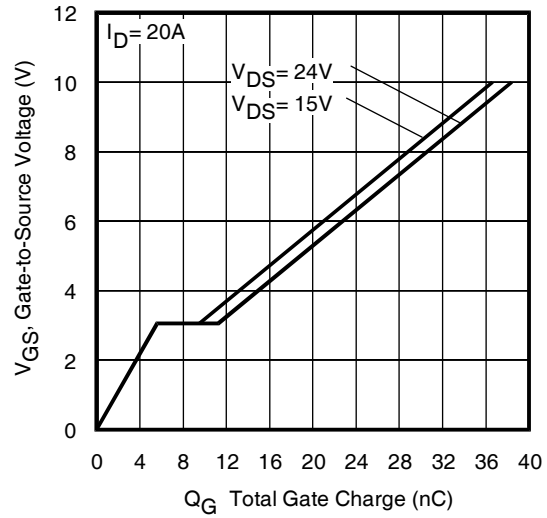
**Fig 3.** Typical Transfer Characteristics



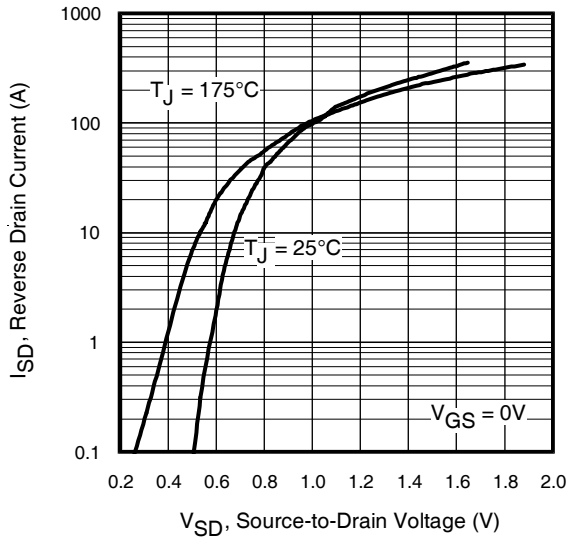
**Fig 4.** Normalized On-Resistance vs. Temperature



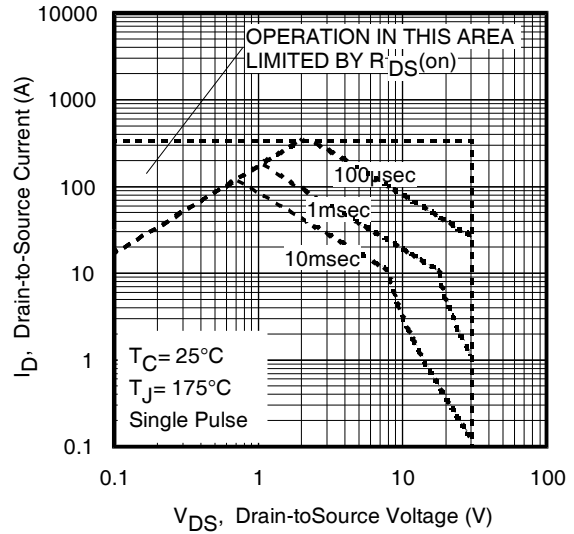
**Fig 5.** Typical Capacitance vs. Drain-to-Source Voltage



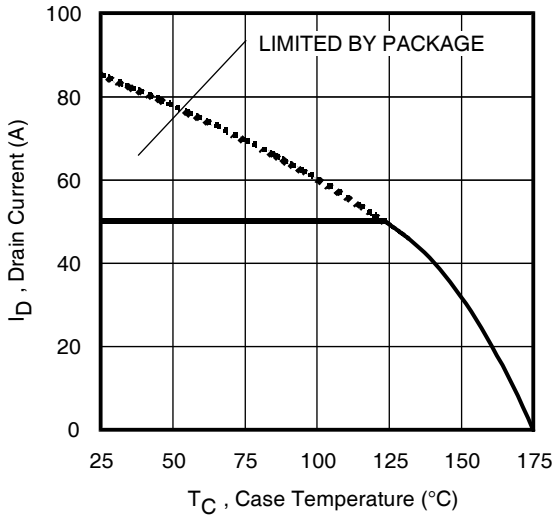
**Fig 6.** Typical Gate Charge vs. Gate-to-Source Voltage



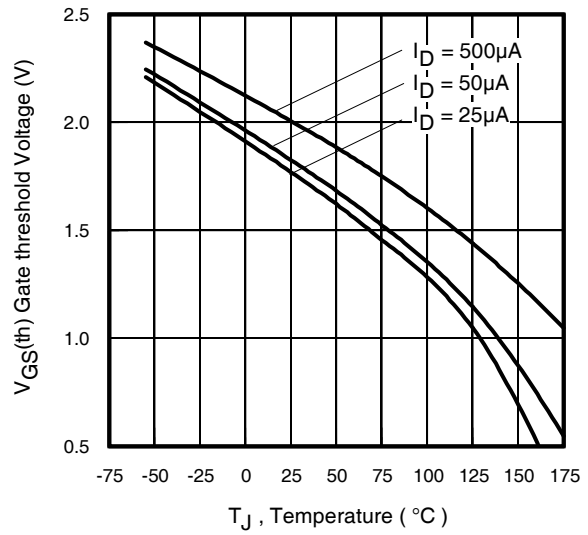
**Fig 7.** Typical Source-Drain Diode Forward Voltage



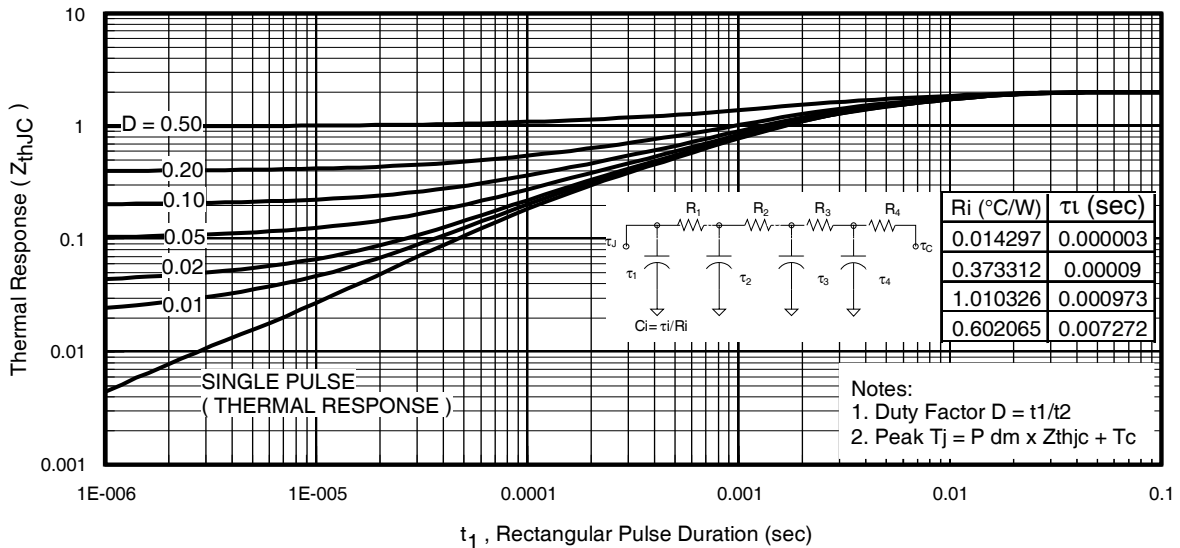
**Fig 8.** Maximum Safe Operating Area



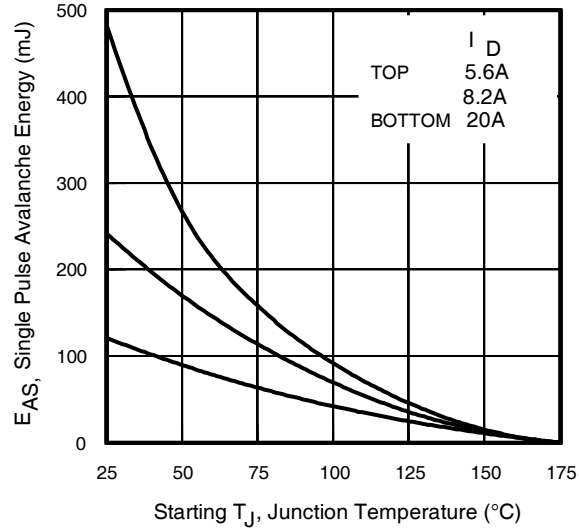
**Fig 9.** Maximum Drain Current vs. Case Temperature



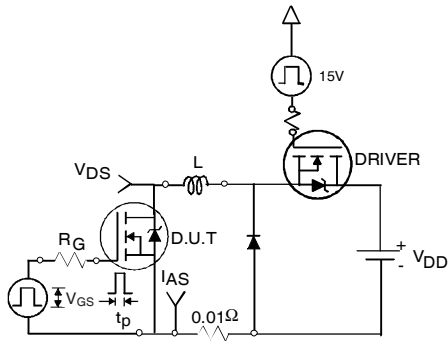
**Fig 10.** Threshold Voltage vs. Temperature



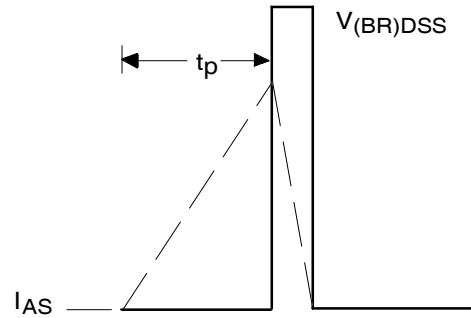
**Fig 11.** Maximum Effective Transient Thermal Impedance, Junction-to-Case



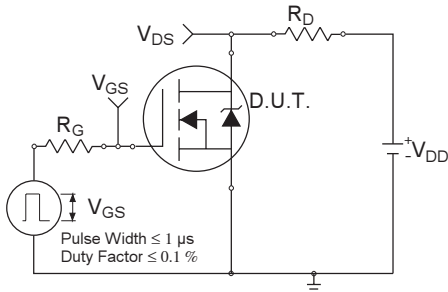
**Fig 12a.** Maximum Avalanche Energy Vs. Drain Current



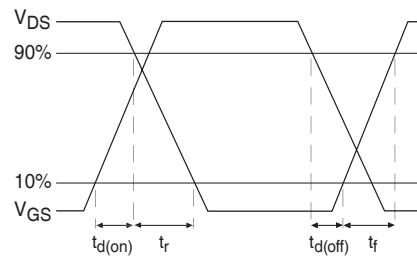
**Fig 12b.** Unclamped Inductive Test Circuit



**Fig 12c.** Unclamped Inductive Waveforms

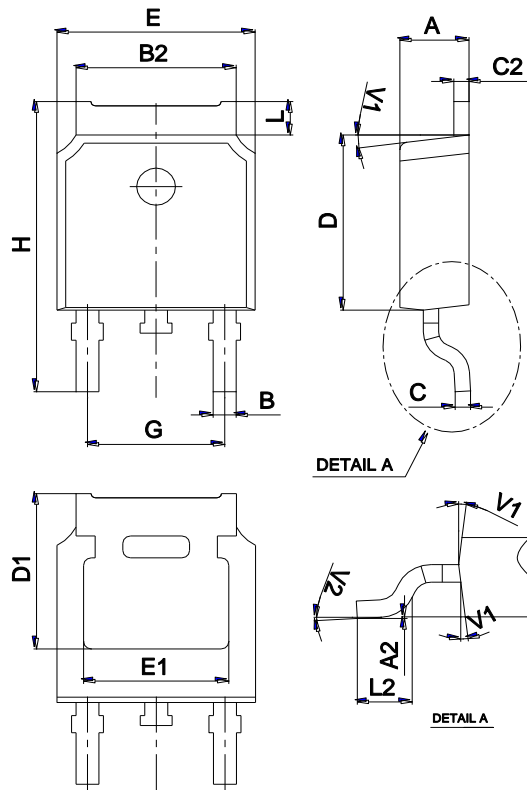


**Fig 13a.** Switching Time Test Circuit



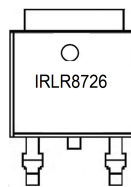
**Fig 13b.** Switching Time Waveforms

**Package Mechanical Data TO-252**



Ref.	Dimensions					
	Millimeters			Inches		
	Min.	Typ.	Max.	Min.	Typ.	Max.
A	2.10		2.50	0.083		0.098
A2	0		0.10	0		0.004
B	0.66		0.86	0.026		0.034
B2	5.18		5.48	0.202		0.216
C	0.40		0.60	0.016		0.024
C2	0.44		0.58	0.017		0.023
D	5.90		6.30	0.232		0.248
D1	5.30REF			0.209REF		
E	6.40		6.80	0.252		0.268
E1	4.63			0.182		
G	4.47		4.67	0.176		0.184
H	9.50		10.70	0.374		0.421
L	1.09		1.21	0.043		0.048
L2	1.35		1.65	0.053		0.065
V1		7°			7°	
V2	0°		6°	0°		6°

**Marking**



**Ordering information**

Order code	Package	Baseqty	Deliverymode
IRLR8726	TO-252	2500	Tape and reel