

Applications

- High Efficiency Synchronous Rectification in SMPS
- Uninterruptible Power Supply
- High Speed Power Switching
- Hard Switched and High Frequency Circuits

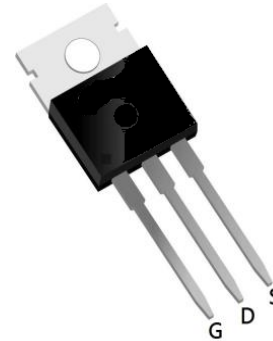

Benefits

- Improved Gate, Avalanche and Dynamic dv/dt Ruggedness
- Fully Characterized Capacitance and Avalanche SOA
- Enhanced body diode dV/dt and dI/dt Capability
- Lead Free
- RoHS Compliant, Halogen-Free
- $V_{DS(V)} = 100V$
- $I_D = 120 A (V_{GS} = 10V)$
- $R_{DS(ON)} < 4.5m\Omega (V_{GS}=10V)$

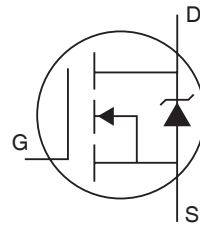

Absolute Maximum Ratings

Symbol	Parameter	Max.		Units
$I_D @ T_C = 25^\circ C$	Continuous Drain Current, $V_{GS} @ 10V$ (Silicon Limited)	180①		A
$I_D @ T_C = 100^\circ C$	Continuous Drain Current, $V_{GS} @ 10V$ (Silicon Limited)	130①		
$I_D @ T_C = 25^\circ C$	Continuous Drain Current, $V_{GS} @ 10V$ (Wire Bond Limited)	120		
I_{DM}	Pulsed Drain Current ②	670		
$P_D @ T_C = 25^\circ C$	Maximum Power Dissipation	370		W
	Linear Derating Factor	2.5		W/°C
V_{GS}	Gate-to-Source Voltage	± 20		V
dv/dt	Peak Diode Recovery ④	5.3		V/ns
T_J T_{STG}	Operating Junction and Storage Temperature Range	-55 to + 175		°C
	Soldering Temperature, for 10 seconds (1.6mm from case)	300		
	Mounting torque, 6-32 or M3 screw	10lb-in (1.1N·m)		
E_{AS} (Thermally limited)	Single Pulse Avalanche Energy ③	190		mJ
I_{AR}	Avalanche Current ②	See Fig. 14, 15, 22a, 22b		A
E_{AR}	Repetitive Avalanche Energy ⑤			mJ
Symbol	Parameter	Typ.	Max.	Units
$R_{\theta JC}$	Junction-to-Case ⑥		0.402	°C/W
$R_{\theta CS}$	Case-to-Sink, Flat Greased Surface	0.50		
$R_{\theta JA}$	Junction-to-Ambient ⑧		62	

Static @ T_J = 25°C (unless otherwise specified)

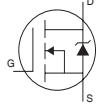
Symbol	Parameter	Min.	Typ.	Max.	Units	Conditions
V _{(BR)DSS}	Drain-to-Source Breakdown Voltage	100			V	V _{GS} = 0V, I _D = 250μA
ΔV _{(BR)DSS/ΔT_J}	Breakdown Voltage Temp. Coefficient		0.108		V/°C	Reference to 25°C, I _D = 5mA ^②
R _{DS(on)}	Static Drain-to-Source On-Resistance		3.7	4.5	mΩ	V _{GS} = 10V, I _D = 75A ^⑤
V _{GS(th)}	Gate Threshold Voltage	2.0		4.0	V	V _{DS} = V _{GS} , I _D = 250μA
I _{DSS}	Drain-to-Source Leakage Current			20	μA	V _{DS} = 100V, V _{GS} = 0V
				250		V _{DS} = 100V, V _{GS} = 0V, T _J = 125°C
I _{GSS}	Gate-to-Source Forward Leakage			100	nA	V _{GS} = 20V
	Gate-to-Source Reverse Leakage			-100		V _{GS} = -20V
Symbol	Parameter	Min.	Typ.	Max.	Units	Conditions
g _{fs}	Forward Transconductance	160			S	V _{DS} = 50V, I _D = 75A
Q _g	Total Gate Charge		150	210	nC	I _D = 75A
Q _{gs}	Gate-to-Source Charge		35			V _{DS} = 50V
Q _{gd}	Gate-to-Drain ("Miller") Charge		43			V _{GS} = 10V ^⑤
R _G	Gate Resistance		1.3		Ω	
t _{d(on)}	Turn-On Delay Time		25		ns	V _{DD} = 65V
t _r	Rise Time		67			I _D = 75A
t _{d(off)}	Turn-Off Delay Time		78			R _G = 2.6Ω
t _f	Fall Time		88			V _{GS} = 10V ^⑤
C _{iss}	Input Capacitance		9620		pF	V _{GS} = 0V
C _{oss}	Output Capacitance		670			V _{DS} = 50V
C _{rss}	Reverse Transfer Capacitance		250			f = 1.0MHz
C _{oss} eff. (ER)	Effective Output Capacitance (Energy Related) ^⑦		820			V _{GS} = 0V, V _{DS} = 0V to 80V ^③
C _{oss} eff. (TR)	Effective Output Capacitance (Time Related) ^⑥		950			V _{GS} = 0V, V _{DS} = 0V to 80V ^⑥
Symbol	Parameter	Min.	Typ.	Max.	Units	Conditions
I _S	Continuous Source Current (Body Diode)			170 ^①	A	MOSFET symbol showing the integral reverse p-n junction diode. 
I _{SM}	Pulsed Source Current (Body Diode) ^{②②}			670		
V _{SD}	Diode Forward Voltage			1.3	V	T _J = 25°C, I _S = 75A, V _{GS} = 0V ^⑤
t _{rr}	Reverse Recovery Time		50	75	ns	T _J = 25°C V _R = 85V, T _J = 125°C I _F = 75A
Q _{rr}	Reverse Recovery Charge		94	140	nC	T _J = 25°C di/dt = 100A/μs ^⑤ T _J = 125°C
I _{RPM}	Reverse Recovery Current		3.5		A	T _J = 25°C
t _{on}	Forward Turn-On Time	Intrinsic turn-on time is negligible (turn-on is dominated by LS+LD)				

Notes:

- ① Calculated continuous current based on maximum allowable junction temperature. Bond wire current limit is 120A. Note that current limitations arising from heating of the device leads may occur with some lead mounting arrangements.
- ② Repetitive rating; pulse width limited by max. junction temperature.
- ③ Limited by T_{Jmax}, starting T_J = 25°C, L = 0.033mH
R_G = 25Ω, I_{AS} = 108A, V_{GS} = 10V. Part not recommended for use above this value.
- ④ I_{SD} ≤ 75A, di/dt ≤ 630A/μs, V_{DD} ≤ V_{(BR)DSS}, T_J ≤ 175°C.
- ⑤ Pulse width ≤ 400μs; duty cycle ≤ 2%.
- ⑥ C_{oss} eff. (TR) is a fixed capacitance that gives the same charging time as C_{oss} while V_{DS} is rising from 0 to 80% V_{DSS}.
- ⑦ C_{oss} eff. (ER) is a fixed capacitance that gives the same energy as C_{oss} while V_{DS} is rising from 0 to 80% V_{DSS}.
- ⑧ R_θ is measured at T_J approximately 90°C.

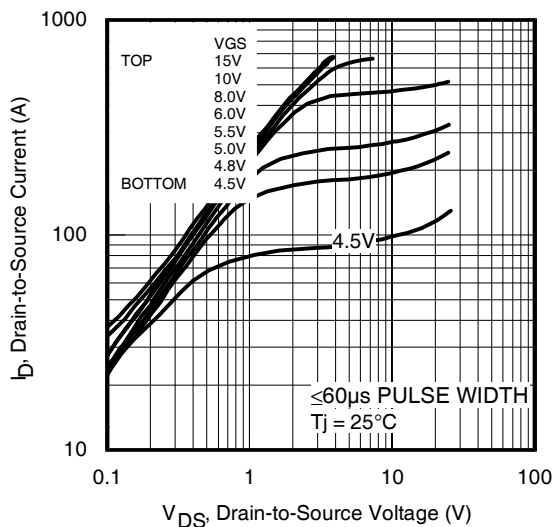

Fig 1. Typical Output Characteristics

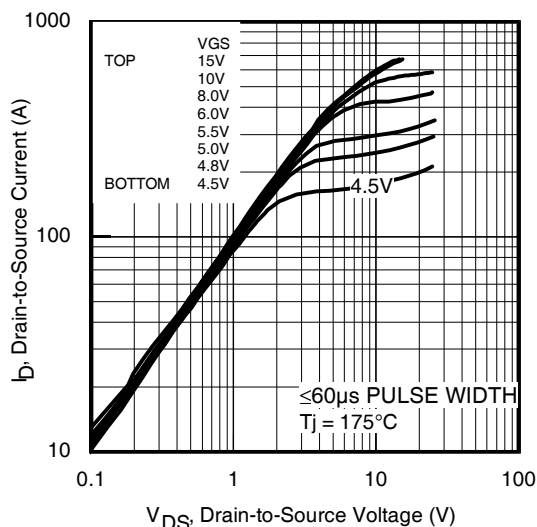

Fig 2. Typical Output Characteristics

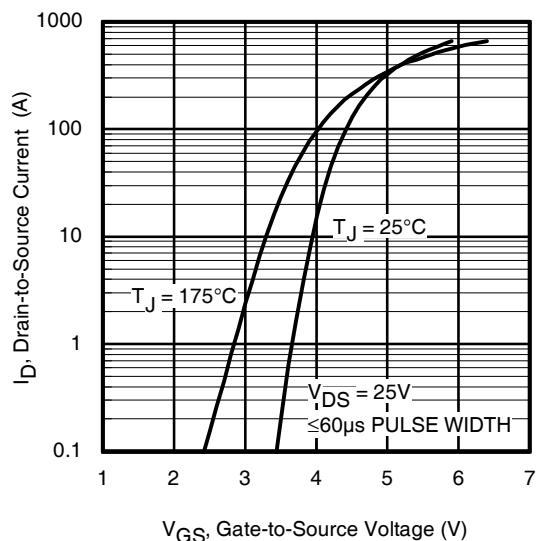

Fig 3. Typical Transfer Characteristics

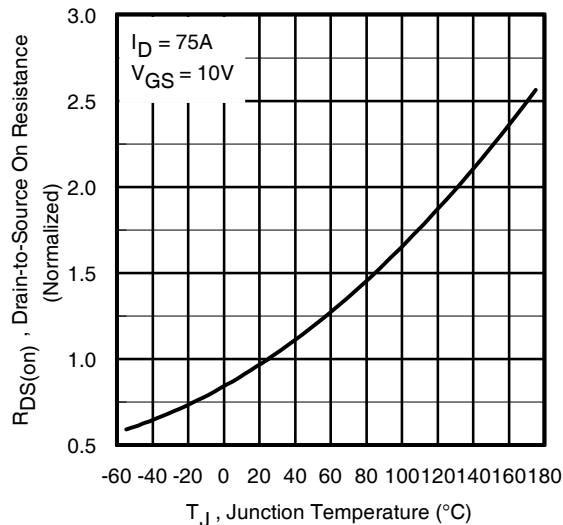

Fig 4. Normalized On-Resistance vs. Temperature

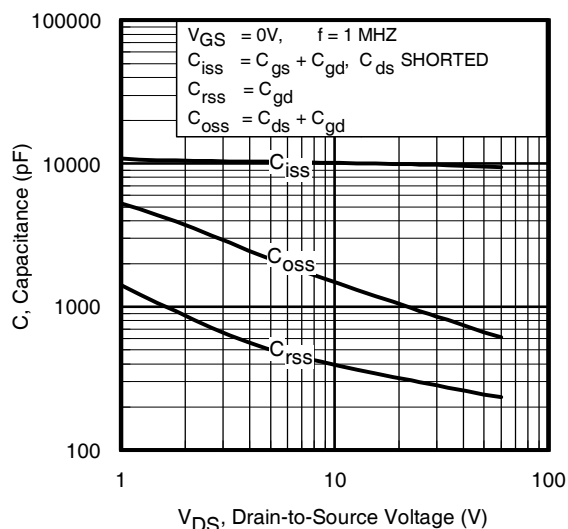

Fig 5. Typical Capacitance vs. Drain-to-Source Voltage

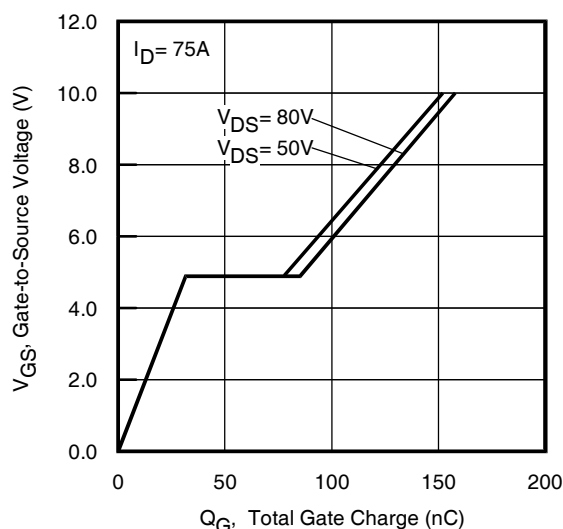

Fig 6. Typical Gate Charge vs. Gate-to-Source Voltage

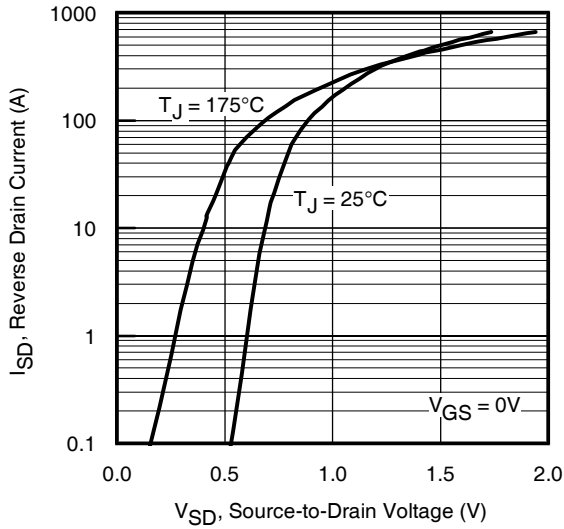

Fig 7. Typical Source-Drain Diode Forward Voltage

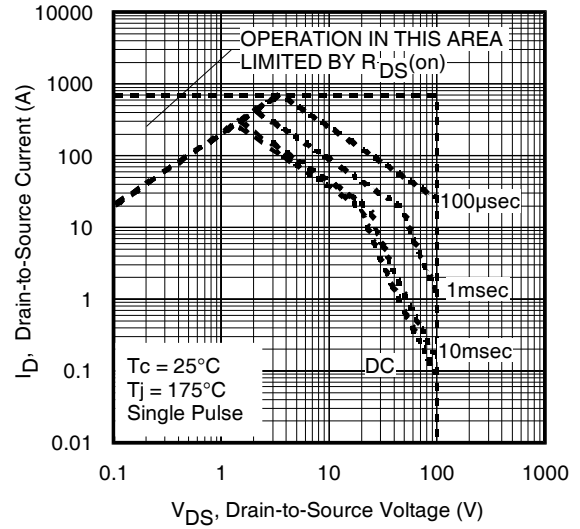

Fig 8. Maximum Safe Operating Area

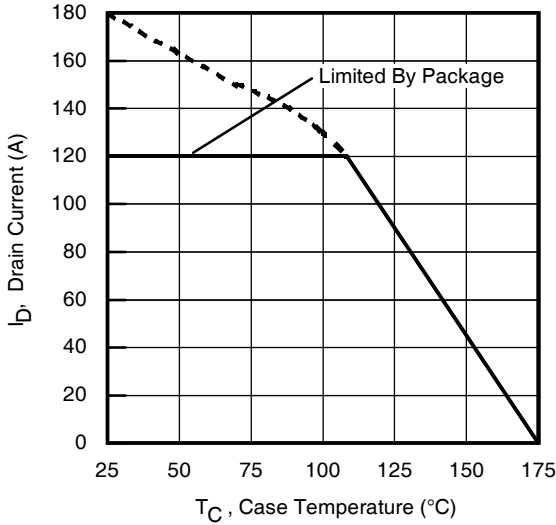

Fig 9. Maximum Drain Current vs. Case Temperature

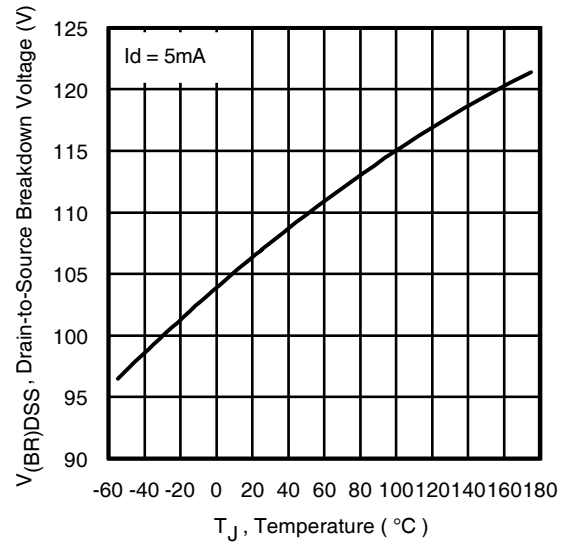

Fig 10. Drain-to-Source Breakdown Voltage

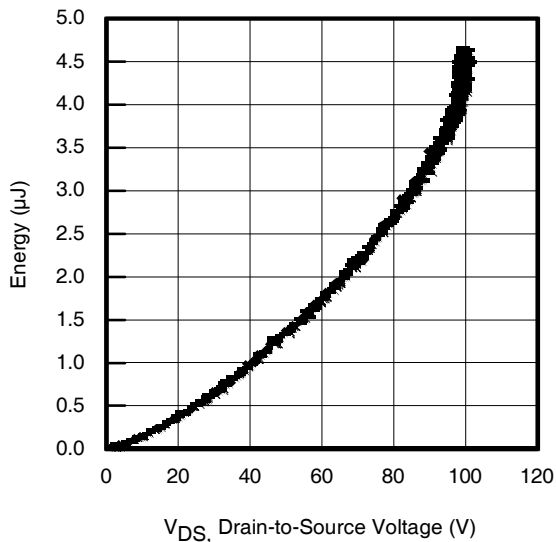

Fig 11. Typical C_{OSS} Stored Energy

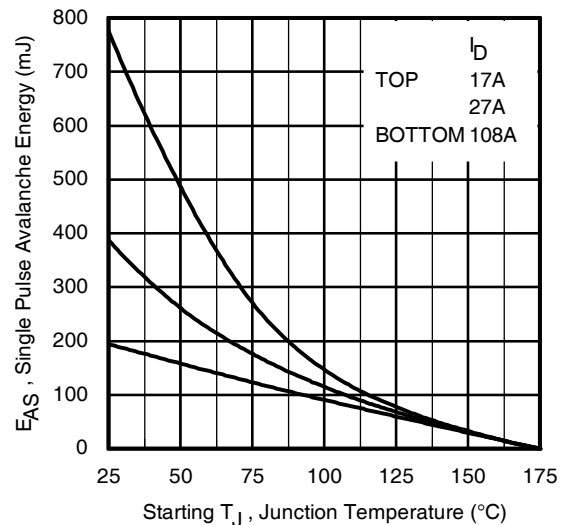

Fig 12. Maximum Avalanche Energy vs. Drain Current

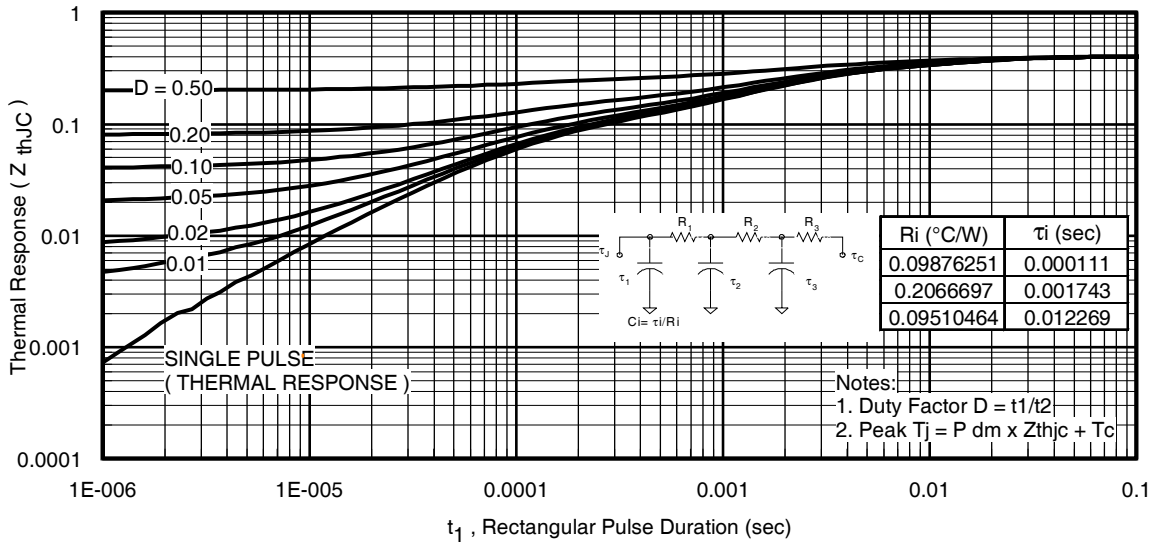

Fig 13. Maximum Effective Transient Thermal Impedance, Junction-to-Case

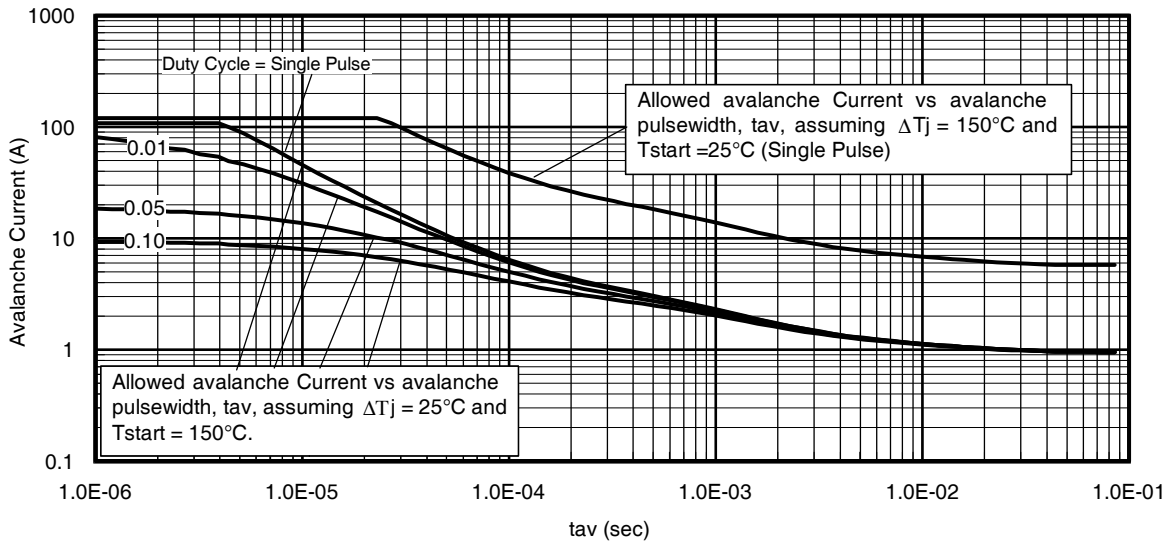

Fig 14. Typical Avalanche Current vs. Pulsewidth

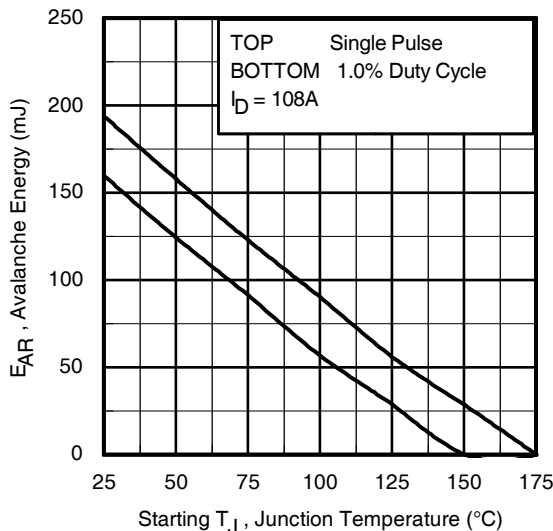

Fig 15. Maximum Avalanche Energy vs. Temperature

Notes on Repetitive Avalanche Curves , Figures 14, 15:

1. Avalanche failures assumption:
Purely a thermal phenomenon and failure occurs at a temperature far in excess of T_{jmax} . This is validated for every part type.
2. Safe operation in Avalanche is allowed as long as T_{jmax} is not exceeded.
3. Equation below based on circuit and waveforms shown in Figures 16a, 16b.
4. $P_{D(ave)}$ = Average power dissipation per single avalanche pulse.
5. BV = Rated breakdown voltage (1.3 factor accounts for voltage increase during avalanche).
6. I_{av} = Allowable avalanche current.
7. ΔT = Allowable rise in junction temperature, not to exceed T_{jmax} (assumed as 25°C in Figure 14, 15).
 t_{av} = Average time in avalanche.
 D = Duty cycle in avalanche = $t_{av} \cdot f$
 $Z_{thJC}(D, t_{av})$ = Transient thermal resistance, see Figures 13)

$$P_{D(ave)} = 1/2 (1.3 \cdot BV \cdot I_{av}) = \Delta T / Z_{thJC}$$

$$I_{av} = 2\Delta T / [1.3 \cdot BV \cdot Z_{th}]$$

$$E_{AS(AR)} = P_{D(ave)} \cdot t_{av}$$

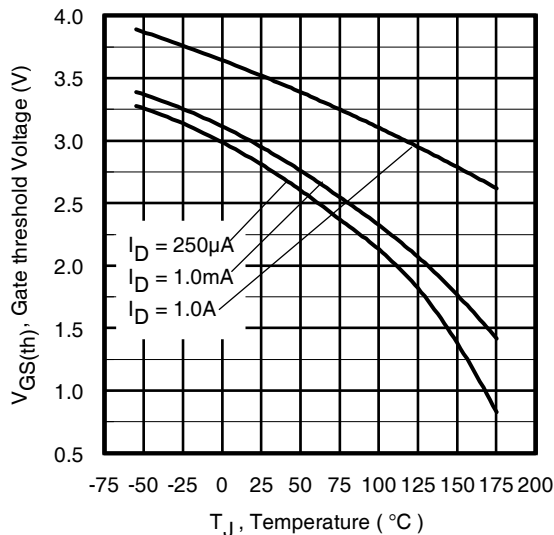

Fig. 16. Threshold Voltage vs. Temperature

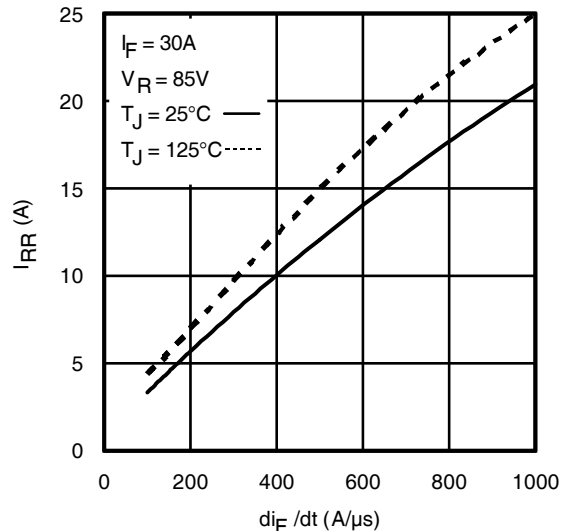

Fig. 17 - Typical Recovery Current vs. di_F/dt

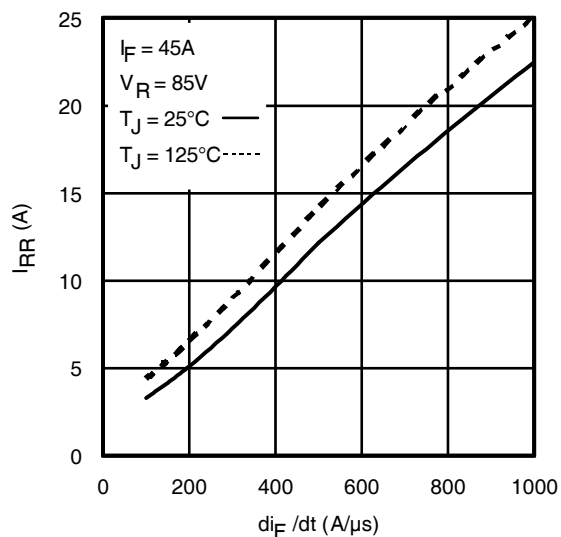

Fig. 18 - Typical Recovery Current vs. di_F/dt

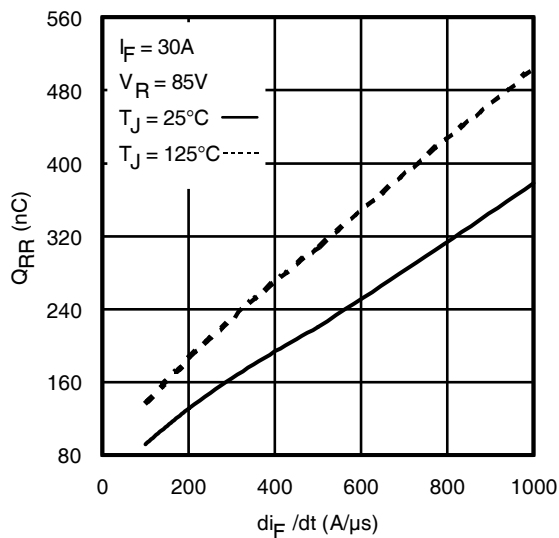

Fig. 19 - Typical Stored Charge vs. di_F/dt

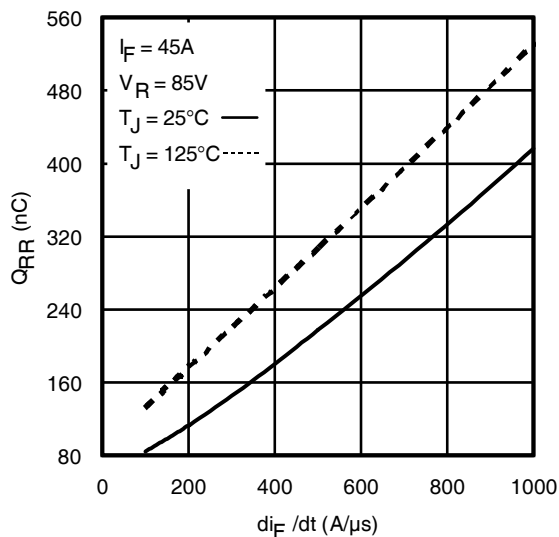

Fig. 20 - Typical Stored Charge vs. di_F/dt

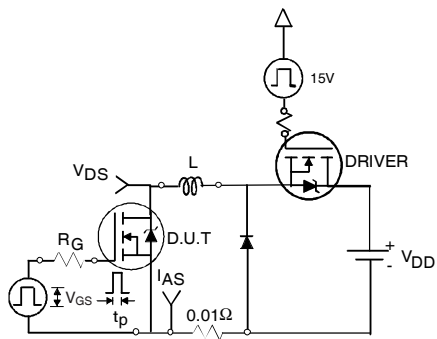

Fig 21a. Unclamped Inductive Test Circuit

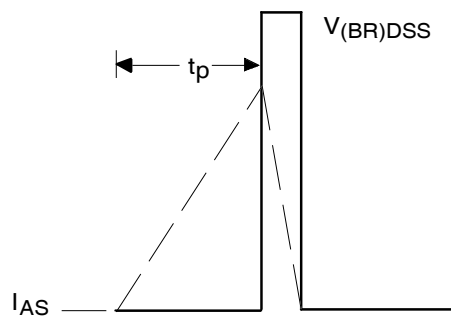

Fig 21b. Unclamped Inductive Waveforms

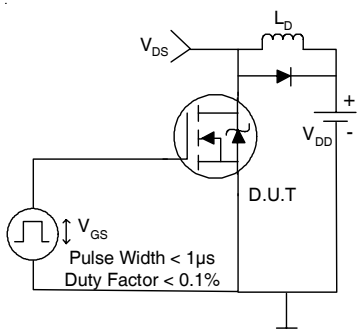

Fig 22a. Switching Time Test Circuit

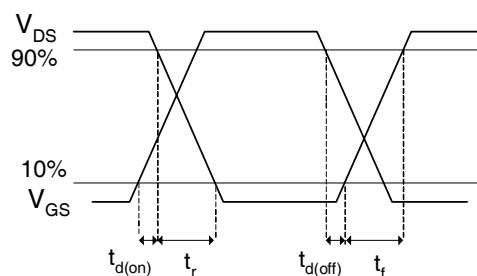

Fig 22b. Switching Time Waveforms

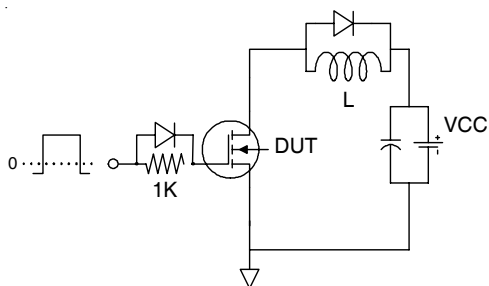

Fig 23a. Gate Charge Test Circuit

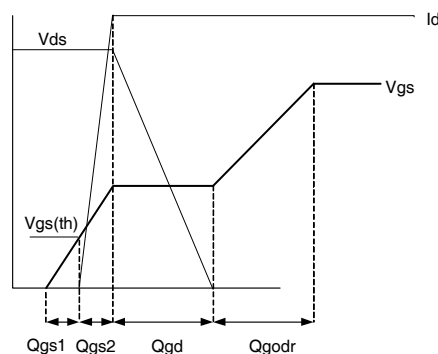
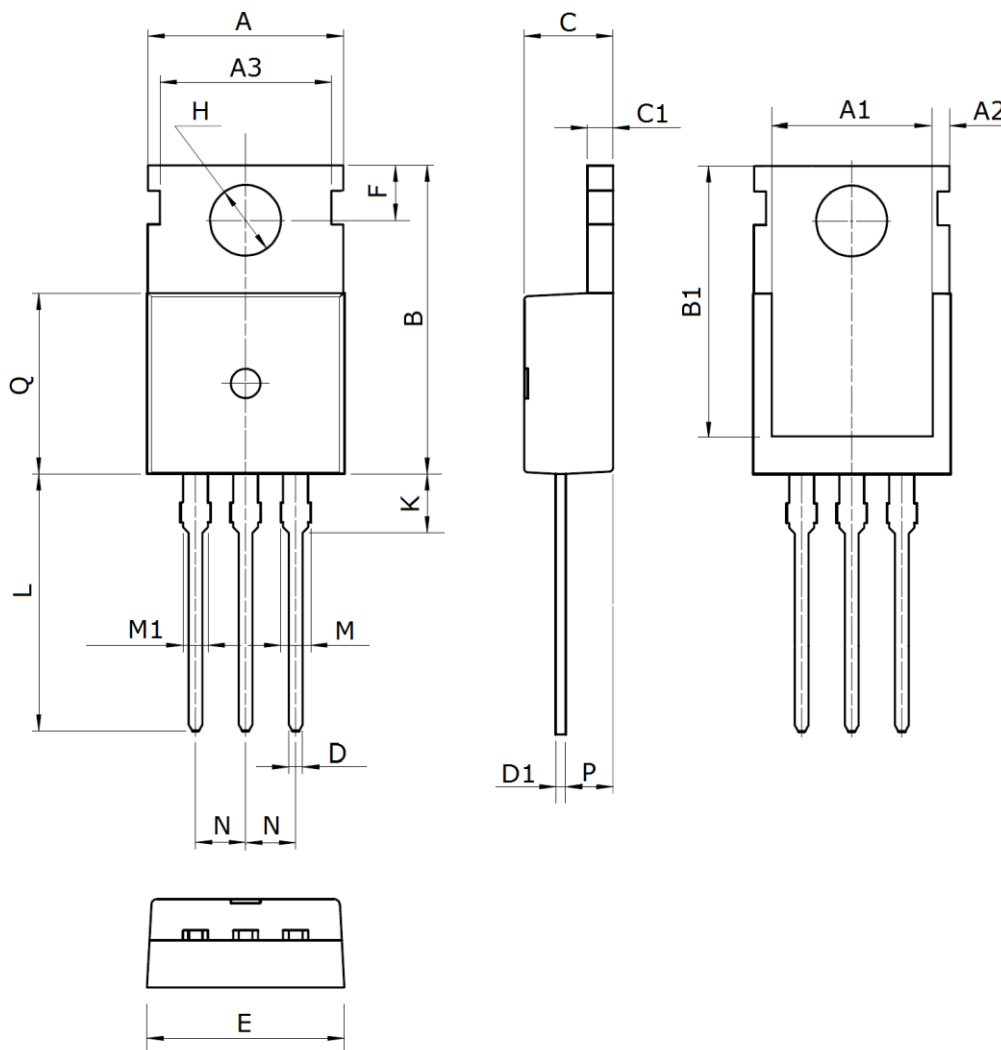

Fig 23b. Gate Charge Waveform

Package Mechanical Data TO-220



Symbol	Dimensions (mm)	Symbol	Dimensions (mm)	Symbol	Dimensions (mm)
A	10.0±0.3	C1	1.3±0.2	L	13.2±0.4
A1	8.0±0.2	D	0.8±0.2	M	1.38±0.1
A2	0.94±0.1	D1	0.5±0.1	M1	1.28±0.1
A3	8.7±0.1	E	10.0±0.3	N	2.54(typ)
B	15.6±0.4	F	2.8 ±0.1	P	2.4±0.3
B1	13.2±0.2	H	3.6±0.1	Q	9.15±0.25
C	4.5±0.2	K	3.1±0.2		

Marking

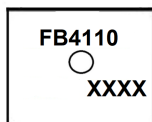

Ordering information

Order code	Package	Baseqty	Deliverymode
IRFB4110	TO-220	1000	Tube and box