

Description:

This P-Channel MOSFET uses advanced trench technology and design to provide excellent $R_{DS(on)}$ with low gate charge. It can be used in a wide variety of applications.

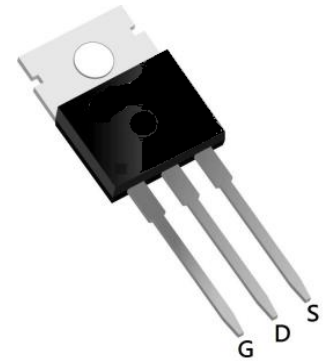

Features:

- 1) $V_{DS}=-100V, I_D=-20A, R_{DS(ON)}<90m\ \Omega$ @ $V_{GS}=-10V$
- 2) Low gate charge.
- 3) Green device available.
- 4) Advanced high cell density trench technology for ultra low $R_{DS(ON)}$.
- 5) Excellent package for good heat dissipation.

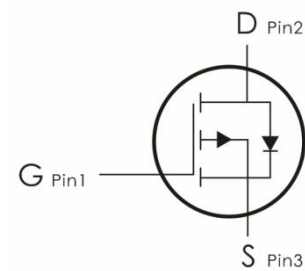

Absolute Maximum Ratings: ($T_C=25^\circ C$ unless otherwise noted)

Symbol	Parameter	Ratings	Units
V_{DS}	Drain-Source Voltage	-100	V
V_{GS}	Gate-Source Voltage	± 20	V
I_D	Continuous Drain Current- $T_C=25^\circ C$	-20	A
	Continuous Drain Current- $T_C=100^\circ C$	-14	A
I_{DM}	Pulsed Drain Current ¹	-85	A
P_D	Total Power Dissipation	58	W
E_{AS}	Single Pulsed Avalanche Energy	177	mJ
T_J, T_{STG}	Operating and Storage Junction Temperature Range	-55 to +150	$^\circ C$

Thermal Characteristics:

Symbol	Parameter	Max	Units
$R_{\theta JC}$	Thermal Resistance, Junction to Case	2.15	°C/W
$R_{\theta JA}$	Thermal Resistance Junction-Ambient	62	°C/W

Electrical Characteristics: ($T_C=25^\circ\text{C}$ unless otherwise noted)

Symbol	Parameter	Conditions	Min	Typ	Max	Units
Off Characteristics						
BV_{DSS}	Drain-Source Breakdown Voltage	$V_{GS}=0V, I_D=-250 \mu A$	-100	---	---	V
I_{DSS}	Zero Gate Voltage Drain Current	$V_{GS}=0V, V_{DS}=-100V$	---	---	-50	μA
I_{GSS}	Gate-Source Leakage Current	$V_{GS}=\pm 20V, V_{DS}=0A$	---	---	± 100	nA
On Characteristics						
$V_{GS(th)}$	GATE-Source Threshold Voltage	$V_{GS}=V_{DS}, I_D=-250 \mu A$	-1.2	-1.7	-2.5	V
$R_{DS(on)}$	Static Drain-Source On-Resistance	$V_{GS}=-10V, I_D=-10A$	---	78	90	m Ω
		$V_{GS}=-4.5V, I_D=-8A$	---	86	110	
Dynamic Characteristics						
C_{iss}	Input Capacitance	$V_{DS}=-20V, V_{GS}=0V, f=1MHz$	---	3020	---	pF
C_{oss}	Output Capacitance		---	120	---	
C_{rss}	Reverse Transfer Capacitance		---	73	---	
Switching Characteristics						
$t_{d(on)}$	Turn-On Delay Time ^{2,3}	$V_{DD}=-50V, I_D=-10A,$ $V_{GS}=-10V, R_G=3.3 \Omega$	---	11	---	ns
t_r	Rise Time ^{2,3}		---	27	---	ns
$t_{d(off)}$	Turn-Off Delay Time ^{2,3}		---	78	---	ns
t_f	Fall Time ^{2,3}		---	53	---	ns
Q_g	Total Gate Charge ^{2,3}		$V_{GS}=-10V, V_{DS}=-50V,$	---	44	---

Q_{gs}	Gate-Source Charge ^{2,3}	I _D =-20A	---	9	---	nC
Q_{gd}	Gate-Drain "Miller" Charge ^{2,3}		---	5.5	---	nC
Drain-Source Diode Characteristics						
V_{SD}	Drain Diode Forward Voltage ²	V _{GS} =0V, I _S =-1A	---	---	-1.2	V
I_S	Continuous Source Current ^{1,5}	V _G =V _D =0V, Force Current	---	---	-20	A
T_{rr}	Reverse Recovery Time	I _F =-8A, di/dt=-100A/μs, T _J =25°C	---	38.7	---	nS
Q_{rr}	Reverse Recovery Charge		---	22.4	---	nC

Notes:

- 1.The data tested by surface mounted on a 1 inch² FR-4 board with 2OZ copper.
- 2.The data tested by pulsed, pulse width ≤ 300us, duty cycle ≤ 2%
- 3.The EAS data shows Max. rating. The test condition is V_{DD}=-25V, V_{GS}=-10V, L=0.88mH, I_{AS}=-18.9A
- 4.The power dissipation is limited by 150°C junction temperature
- 5.The data is theoretically the same as I_D and I_{DM}, in real applications, should be limited by total power dissipation.

Typical Characteristics: (T_C=25°C unless otherwise noted)

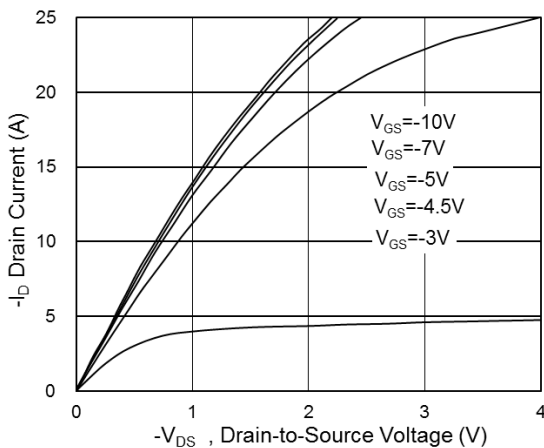

Fig.1 Typical Output Characteristics

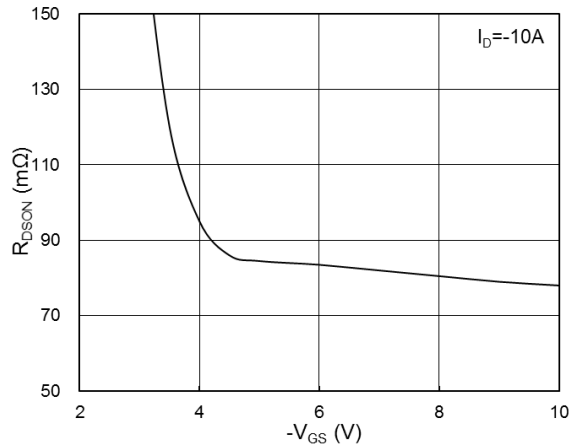

Fig.2 On-Resistance vs G-S Voltage

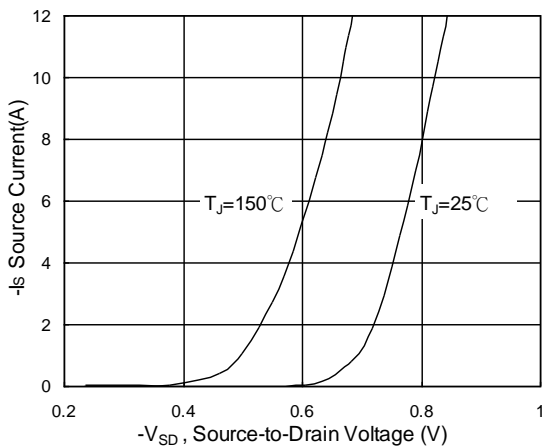

Fig.3 Typical S-D Diode Forward Voltage

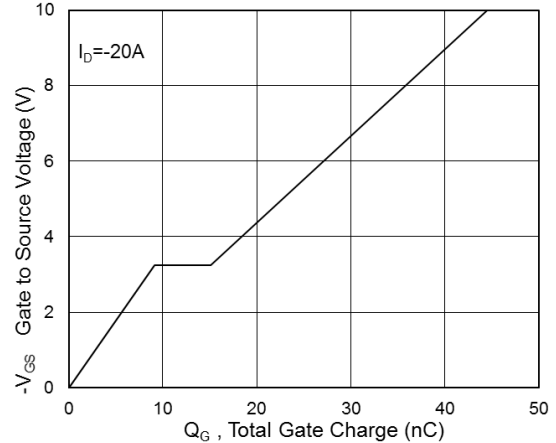

Fig.4 Gate-Charge Characteristics

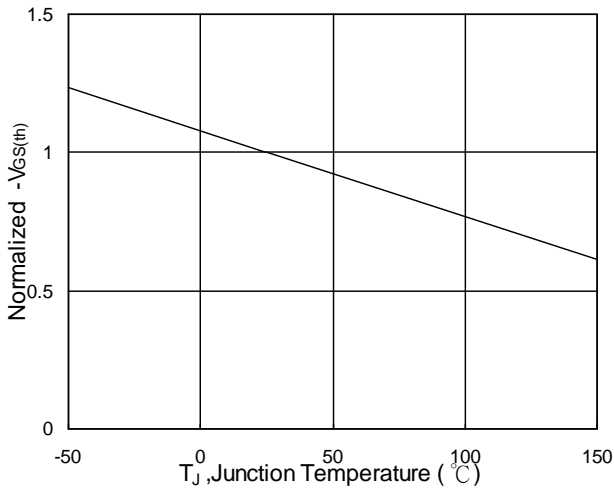

Fig.5 Normalized $V_{GS(th)}$ vs T_J

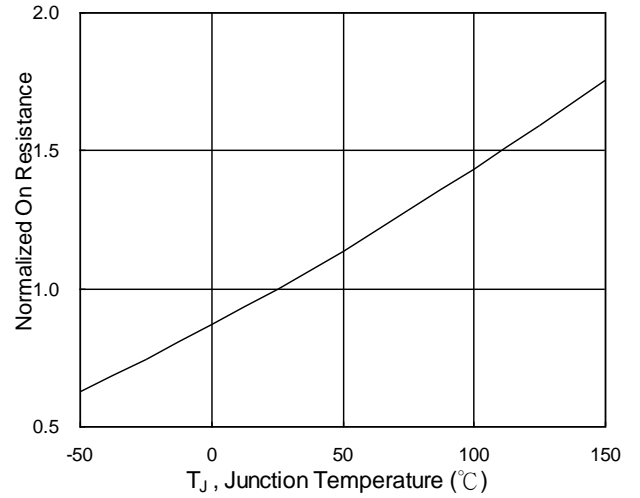

Fig.6 Normalized $R_{DS(on)}$ vs T_J

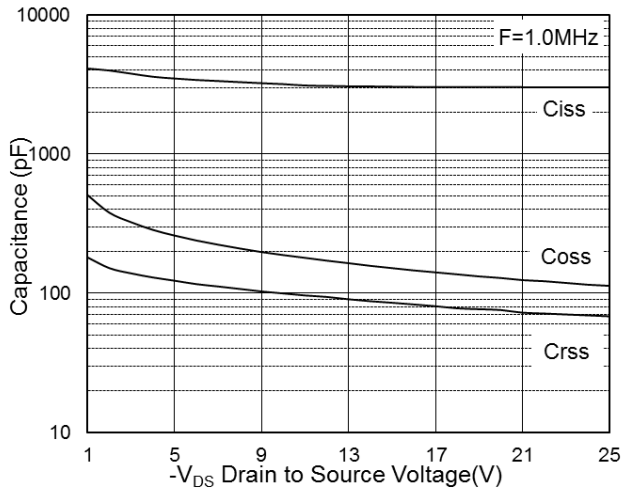

Fig.7 Capacitance

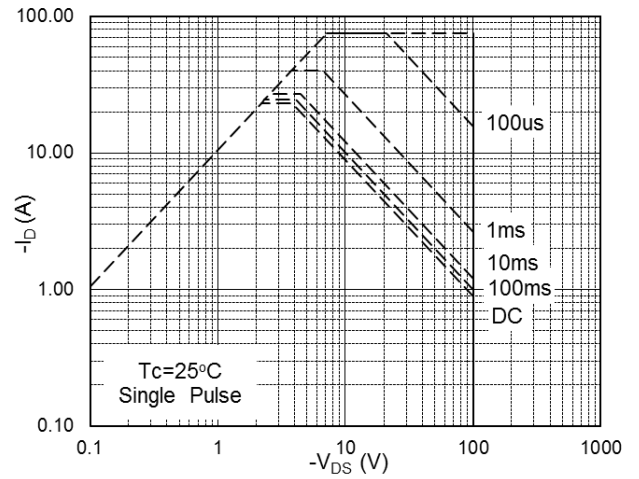

Fig.8 Safe Operating Area

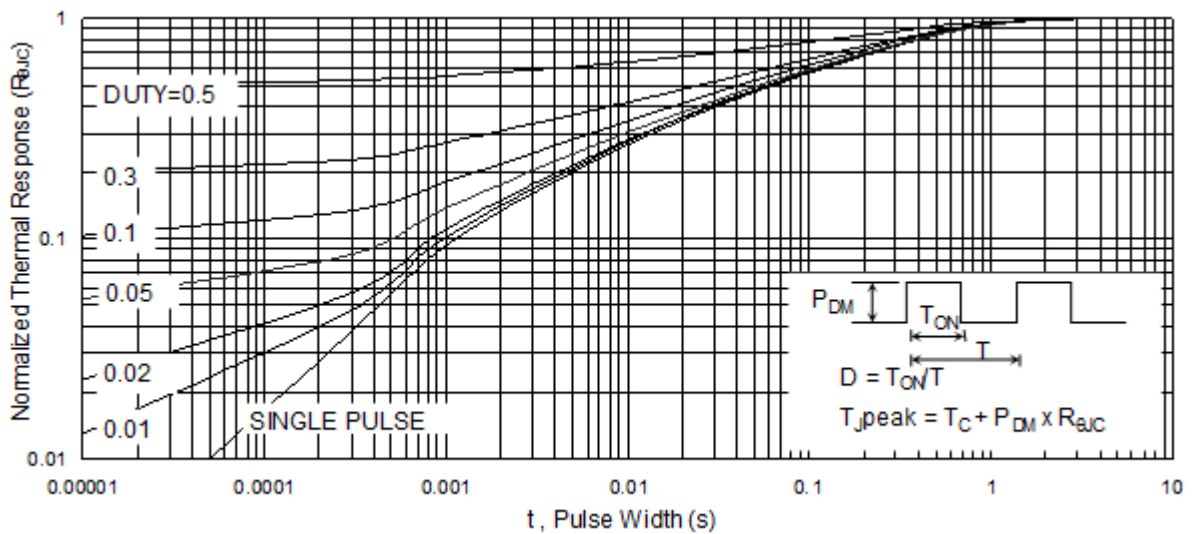

Fig.9 Normalized Maximum Transient Thermal Impedance

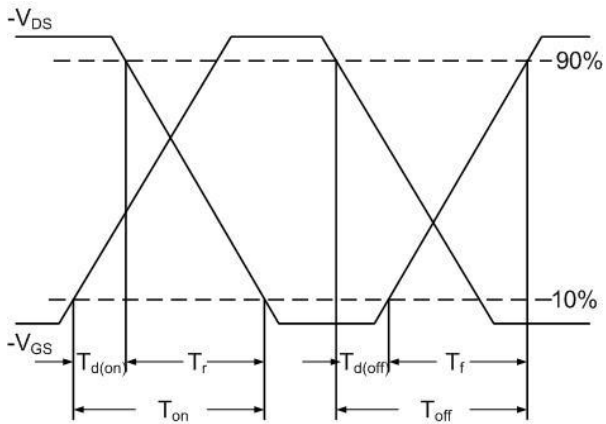

Fig.10 Switching Time Waveform

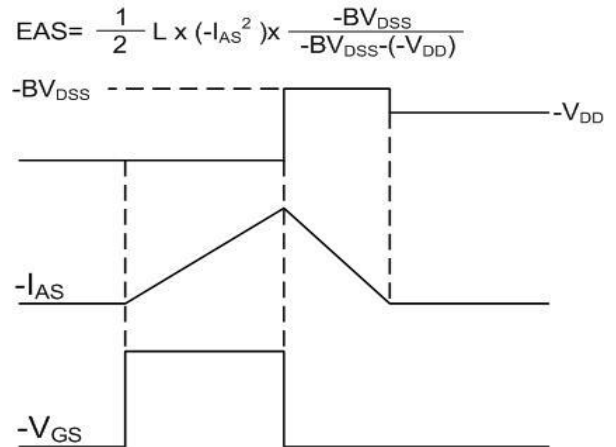
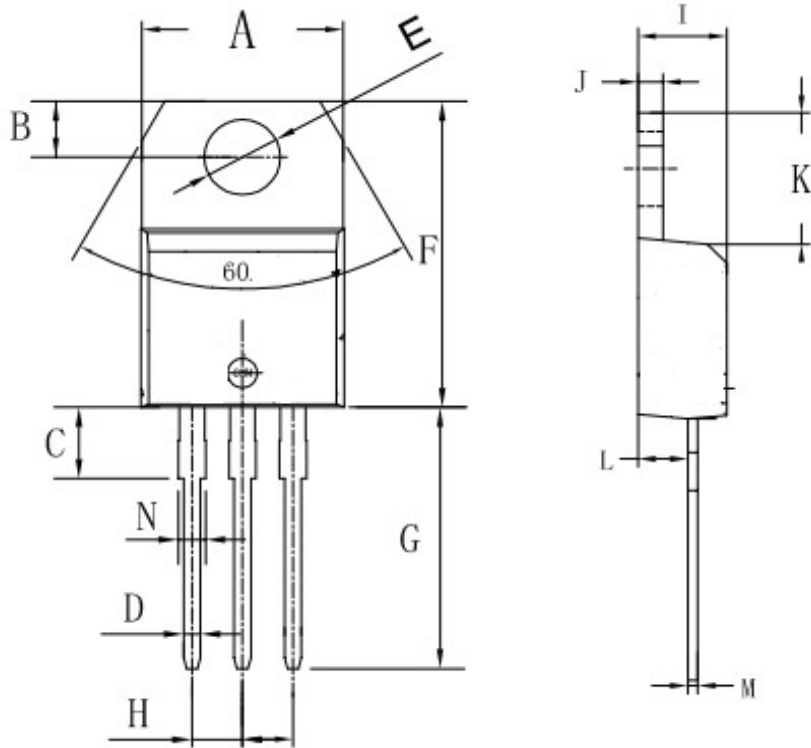

Fig.11 Unclamped Inductive Waveform

Package Dimensions



Symbol	Dimensions In Millimeters		Dimensions In Inches	
	Min	Max	Min	Max
A	9.8	10.4	0.385	0.409
B	2.65	3.1	0.104	0.122
C	2.8	4.2	0.110	0.165
D	0.7	0.92	0.027	0.036
E	3.75	3.95	0.147	0.155
F	14.8	16.1	0.582	0.633
G	13.05	13.6	0.513	0.535
H	2.4	2.7	0.094	0.106
I	4.38	4.61	0.172	0.181
J	1.15	1.36	0.045	0.053
K	5.85	6.82	0.230	0.268
L	2.35	2.75	0.092	0.108
M	0.35	0.65	0.013	0.025
N	1.18	1.42	0.046	0.055