

Features

- $V_{DS(V)} = -40V$
- $I_D = -6.2A (V_{GS} = -10V)$
- $R_{DS(ON)} < 41m\Omega (V_{GS} = -10V)$
- $R_{DS(ON)} < 70m\Omega (V_{GS} = -4.5V)$
- Trench Technology
- Ultra Low On-Resistance
- P-Channel MOSFET
- Lead-Free

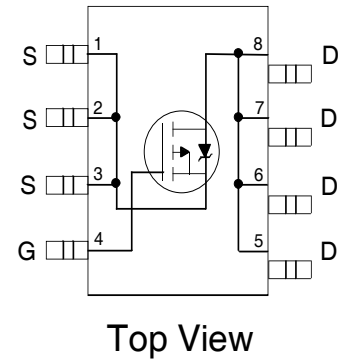

Absolute Maximum Ratings

	Parameter	Max.	Units
V_{DS}	Drain- Source Voltage	-40	V
$I_D @ T_A = 25^\circ C$	Continuous Drain Current, $V_{GS} @ -10V$	-6.2	A
$I_D @ T_A = 70^\circ C$	Continuous Drain Current, $V_{GS} @ -10V$	-4.9	
I_{DM}	Pulsed Drain Current ①	-25	
$P_D @ T_A = 25^\circ C$	Power Dissipation ③	2.5	W
$P_D @ T_A = 70^\circ C$	Power Dissipation ③	1.6	
	Linear Derating Factor	20	mW/°C
V_{GS}	Gate-to-Source Voltage	± 20	V
T_J, T_{STG}	Junction and Storage Temperature Range	-55 to + 150	°C

Thermal Resistance

Symbol	Parameter	Typ.	Max.	Units
$R_{\theta JL}$	Junction-to-Drain Lead		20	°C/W
$R_{\theta JA}$	Junction-to-Ambient ③		50	

Electrical Characteristics @ T_J = 25°C (unless otherwise specified)

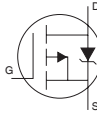
	Parameter	Min.	Typ.	Max.	Units	Conditions
V _{(BR)DSS}	Drain-to-Source Breakdown Voltage	-40			V	V _{GS} = 0V, I _D = -250μA
ΔV _{(BR)DSS/ΔT_J}	Breakdown Voltage Temp. Coefficient		0.03		V/°C	Reference to 25°C, I _D = -1mA
R _{DS(on)}	Static Drain-to-Source On-Resistance		25	41	mΩ	V _{GS} = -10V, I _D = -6.2A ②
			45	70		V _{GS} = -4.5V, I _D = -5.0A ②
V _{GS(th)}	Gate Threshold Voltage	-1.0		-3.0	V	V _{DS} = V _{GS} , I _D = -250μA
g _{fs}	Forward Transconductance	8.9			S	V _{DS} = -10V, I _D = -6.2A
I _{DSS}	Drain-to-Source Leakage Current			-10	μA	V _{DS} = -32V, V _{GS} = 0V
				-25		V _{DS} = -32V, V _{GS} = 0V, T _J = 70°C
I _{GSS}	Gate-to-Source Forward Leakage			-100	nA	V _{GS} = -20V
	Gate-to-Source Reverse Leakage			100		V _{GS} = 20V
Q _g	Total Gate Charge		53	80	nC	I _D = -6.2A
Q _{gs}	Gate-to-Source Charge		14	21		V _{DS} = -32V
Q _{gd}	Gate-to-Drain ("Miller") Charge		3.9	5.9		V _{GS} = -10V
t _{d(on)}	Turn-On Delay Time		24		ns	V _{DD} = -20V ③
t _r	Rise Time		280			I _D = -1.0A
t _{d(off)}	Turn-Off Delay Time		210			R _G = 6.0Ω
t _f	Fall Time		100			V _{GS} = -10V
C _{iss}	Input Capacitance		3220		pF	V _{GS} = 0V
C _{oss}	Output Capacitance		160			V _{DS} = -25V
C _{rss}	Reverse Transfer Capacitance		190			f = 1.0kHz
I _S	Continuous Source Current (Body Diode)			-2.5	A	MOSFET symbol showing the integral reverse p-n junction diode. 
I _{SM}	Pulsed Source Current (Body Diode) ①			-25		
V _{SD}	Diode Forward Voltage			-1.2	V	T _J = 25°C, I _S = -2.5A, V _{GS} = 0V ③
t _{rr}	Reverse Recovery Time		32	48	ns	T _J = 25°C, I _F = -2.5A
Q _{rr}	Reverse Recovery Charge		45	68	nC	di/dt = -100A/μs ②

Notes:

- ① Repetitive rating; pulse width limited by max. junction temperature.
- ② Pulse width ≤ 400μs; duty cycle ≤ 2%.
- ③ Surface mounted on 1 in square Cu board

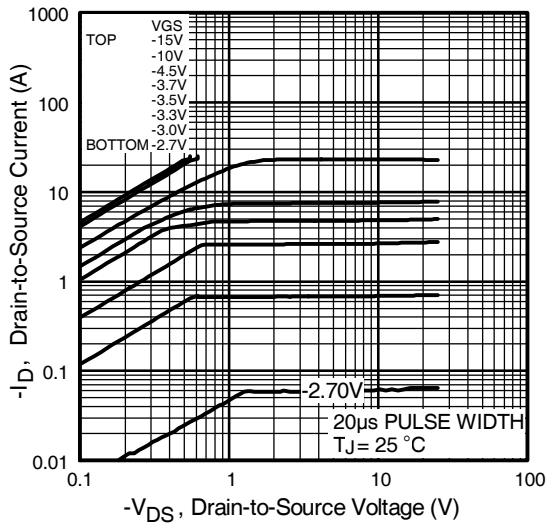

Fig 1. Typical Output Characteristics

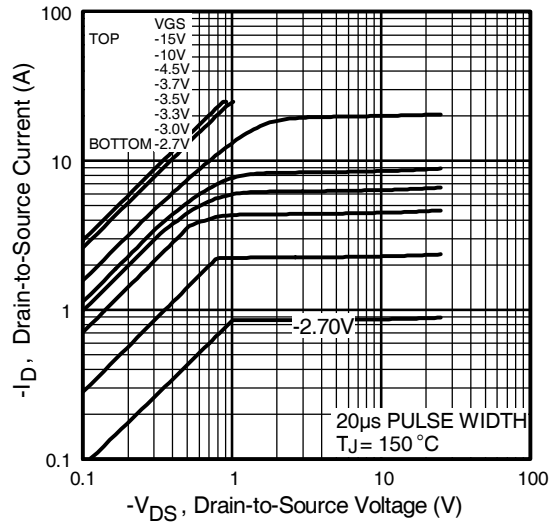

Fig 2. Typical Output Characteristics

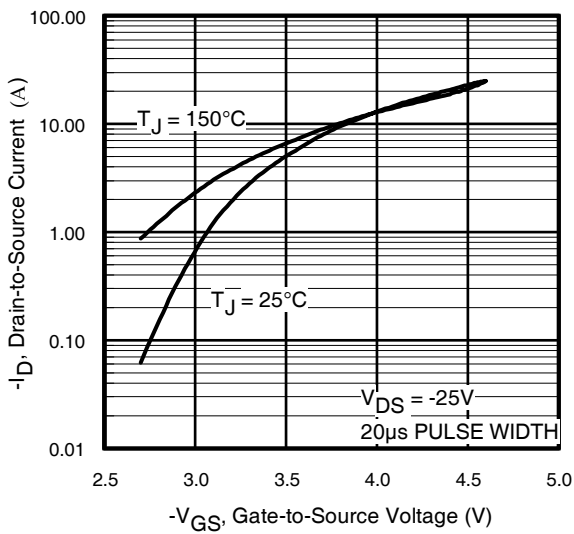

Fig 3. Typical Transfer Characteristics

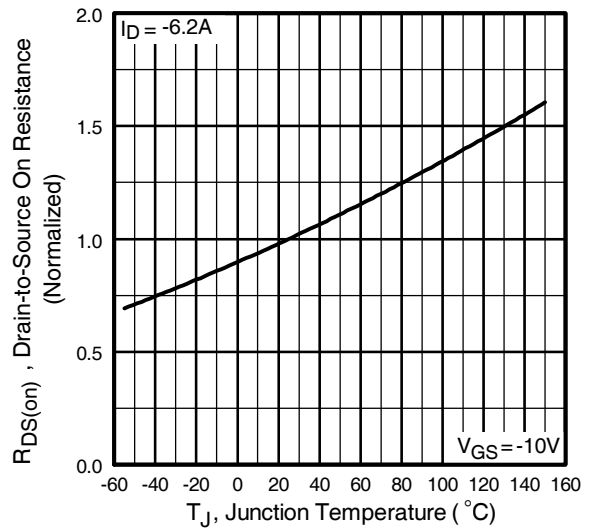

Fig 4. Normalized On-Resistance Vs. Temperature

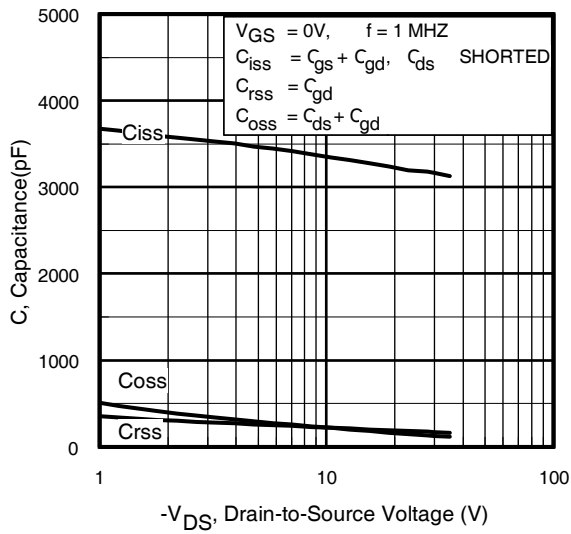

Fig 5. Typical Capacitance Vs. Drain-to-Source Voltage

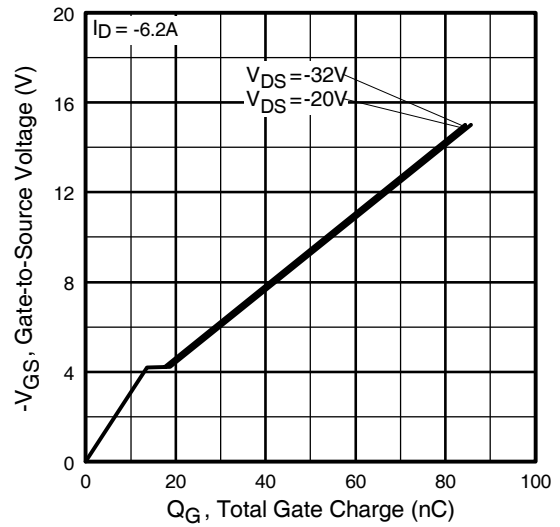

Fig 6. Typical Gate Charge Vs. Gate-to-Source Voltage

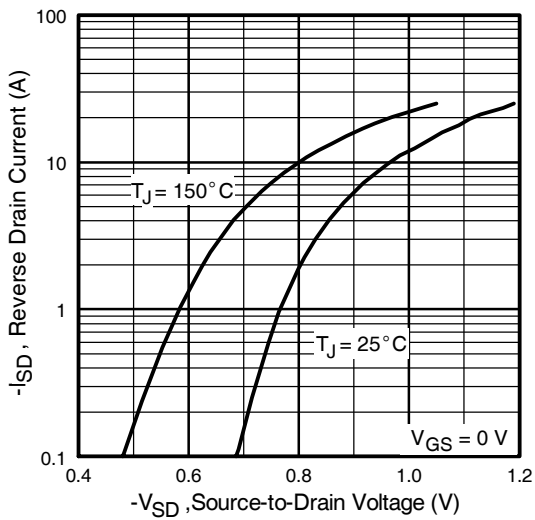

Fig 7. Typical Source-Drain Diode Forward Voltage

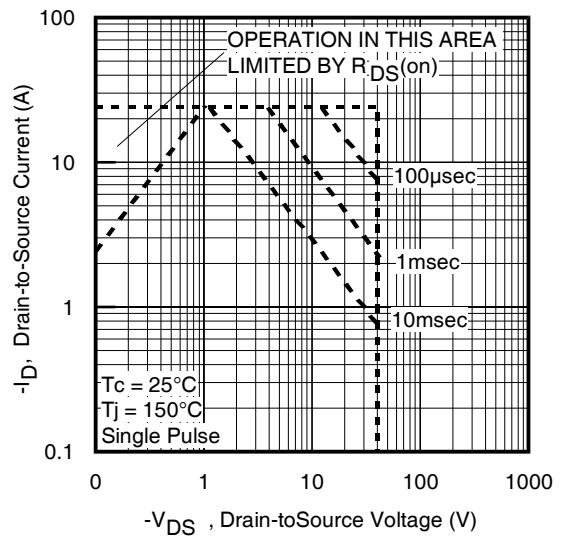

Fig 8. Maximum Safe Operating Area

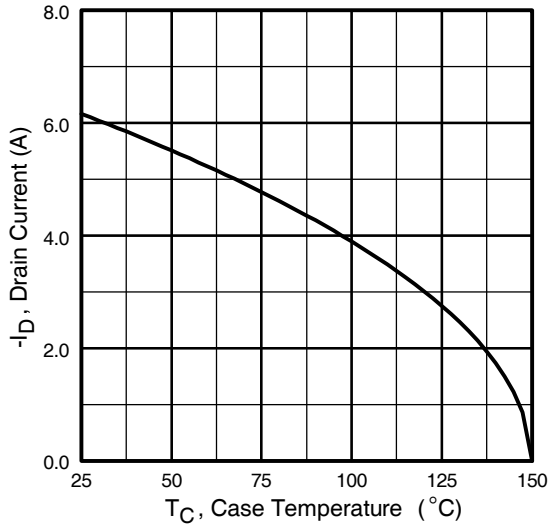

Fig 9. Maximum Drain Current Vs. Case Temperature

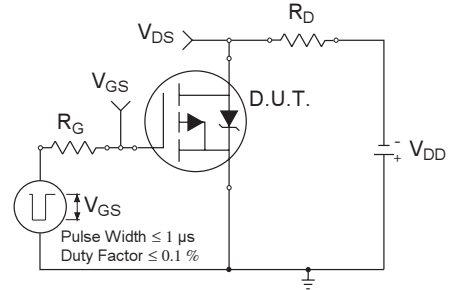

Fig 10a. Switching Time Test Circuit

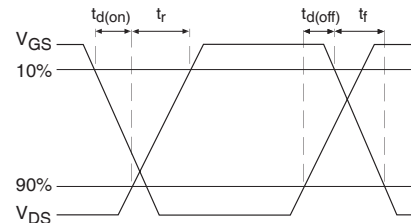

Fig 10b. Switching Time Waveforms

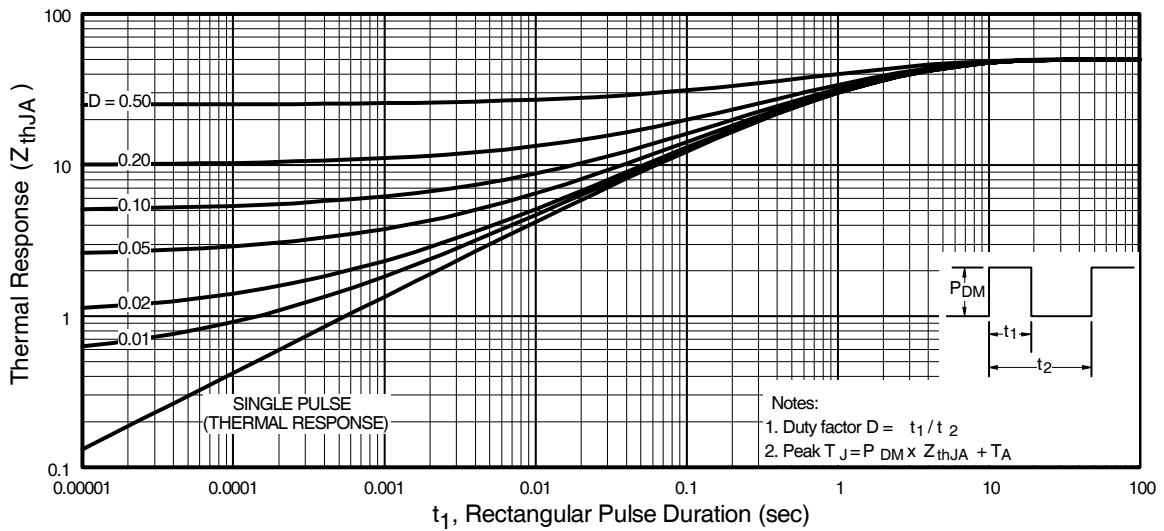

Fig 11. Maximum Effective Transient Thermal Impedance, Junction-to-Ambient

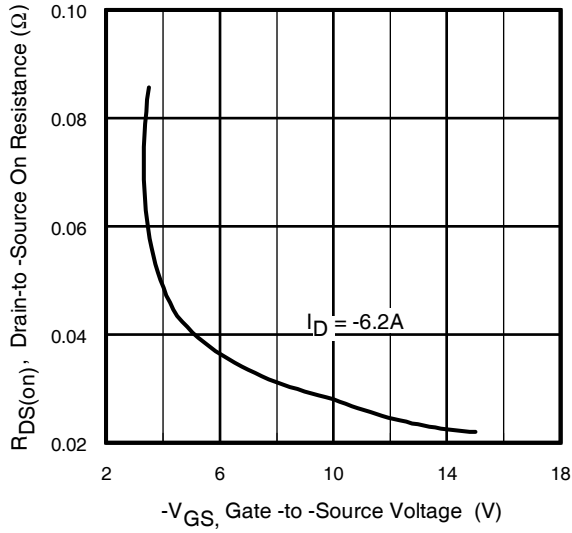

Fig 12. Typical On-Resistance Vs. Gate Voltage

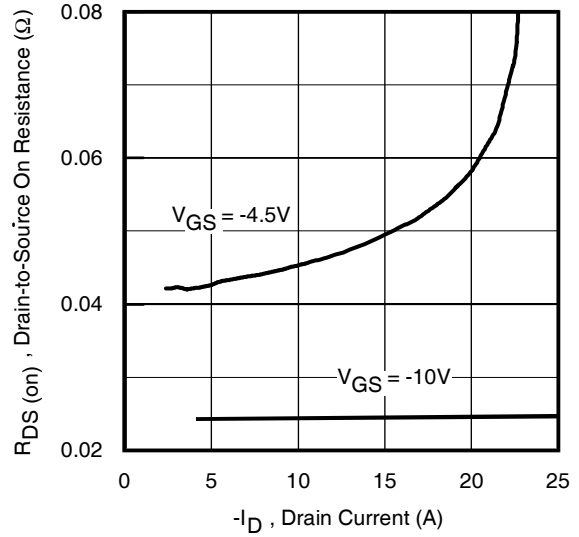

Fig 13. Typical On-Resistance Vs. Drain Current

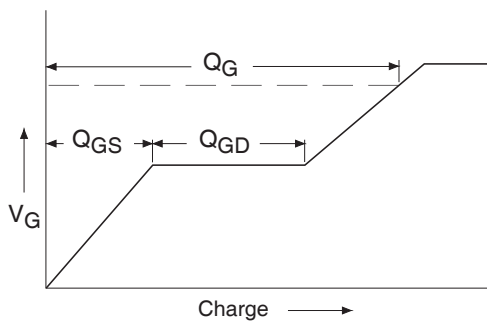

Fig 14a. Basic Gate Charge Waveform

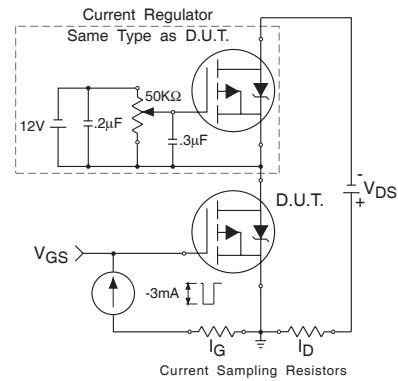

Fig 14b. Gate Charge Test Circuit

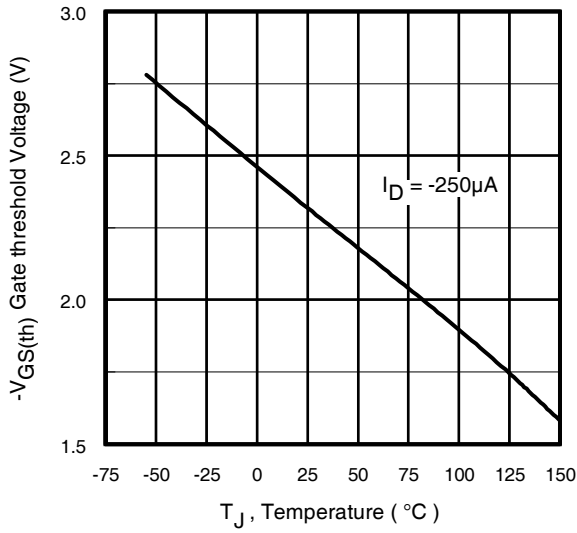

Fig 15. Typical V_{GS(th)} Vs. Junction Temperature

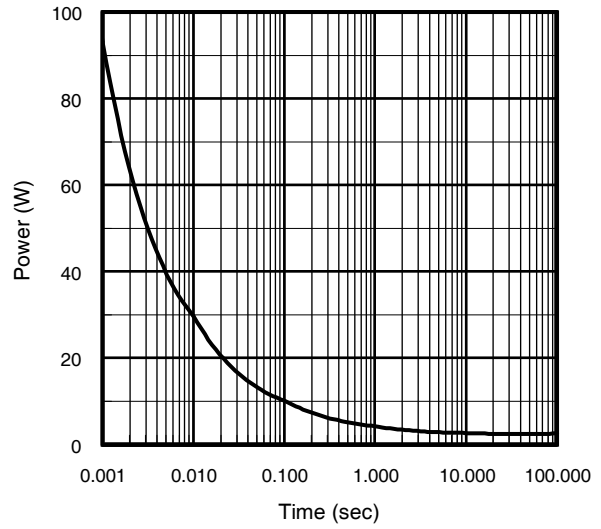
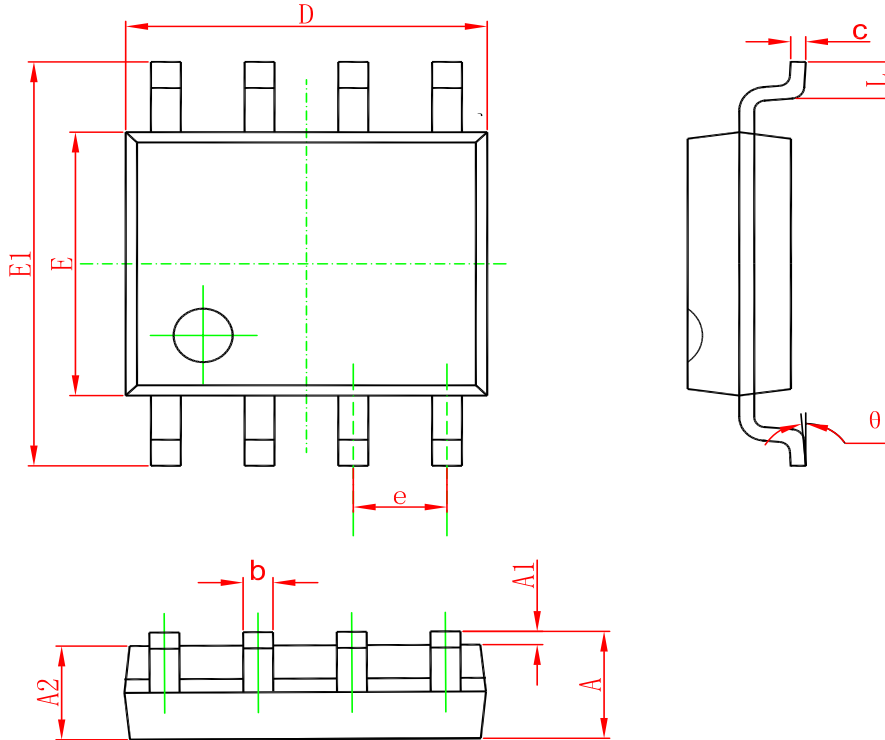

Fig 16. Typical Power Vs. Time

PACKAGE OUTLINE DIMENSIONS

SOP-8



Symbol	Dimensions In Millimeters		Dimensions In Inches	
	Min	Max	Min	Max
A	1.350	1.750	0.053	0.069
A1	0.100	0.250	0.004	0.010
A2	1.350	1.550	0.053	0.061
b	0.330	0.510	0.013	0.020
c	0.170	0.250	0.006	0.010
D	4.700	5.100	0.185	0.200
E	3.800	4.000	0.150	0.157
E1	5.800	6.200	0.228	0.244
e	1.270(BSC)		0.050(BSC)	
L	0.400	1.270	0.016	0.050
θ	0°	8°	0°	8°

Marking

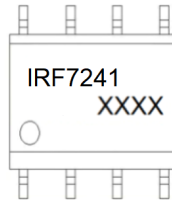

Ordering information

Order code	Package	Baseqty	Deliverymode
IRF7241	SOP-8	3000	Tape and reel