

EVVOSEMI[®]

THINK CHANGE DO



ESD



TVS



MOS



LDO

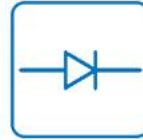

Diode



Sensor



DC-DC

Product Specification

▶ Domestic	Part Number	AOD409
▶ Overseas	Part Number	AOD409
▶ Equivalent	Part Number	AOD409

EV is the abbreviation of name EVVO

P-Channel -60 V (D-S) MOSFET

General Description

The AOD409 uses advanced trench technology to provide excellent $R_{DS(ON)}$, low gate charge and low gate resistance. With the excellent thermal resistance of the TO-252 package, this device is well suited for high current load applications.

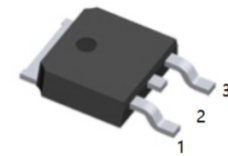

1.G 2.D 3.S
TO-252(DPAK) top view

Features

V_{DS} (V) = -60V

I_D = -26A (V_{GS} = -10V)

$R_{DS(ON)}$ < 48m Ω (V_{GS} = -10V) @ -20A

$R_{DS(ON)}$ < 55m Ω (V_{GS} = -4.5V)

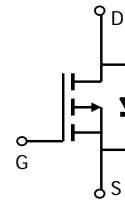

Absolute Maximum Ratings $T_A = 25^\circ\text{C}$ unless otherwise noted

Parameter	Symbol	Maximum	Units
Drain-Source Voltage	V_{DS}	-60	V
Gate-Source Voltage	V_{GS}	± 20	V
Continuous Drain Current ^G	I_D	$T_C = 25^\circ\text{C}$	A
		$T_C = 100^\circ\text{C}$	
Pulsed Drain Current ^C	I_{DM}	-60	
Avalanche Current ^C	I_{AR}	-26	A
Repetitive avalanche energy $L=0.1\text{mH}$ ^C	E_{AR}	33.8	mJ
Power Dissipation ^B	P_D	$T_C = 25^\circ\text{C}$	W
		$T_C = 100^\circ\text{C}$	
Power Dissipation ^A	P_{DSM}	$T_A = 25^\circ\text{C}$	W
		$T_A = 70^\circ\text{C}$	
Junction and Storage Temperature Range	T_J, T_{STG}	-55 to 175	$^\circ\text{C}$

Thermal Characteristics

Parameter	Symbol	Typ	Max	Units
Maximum Junction-to-Ambient ^A	$R_{\theta JA}$	$t \leq 10\text{s}$	16.7	$^\circ\text{C/W}$
Maximum Junction-to-Ambient ^A		Steady-State	40	
Maximum Junction-to-Case ^C	$R_{\theta JC}$	1.9	2.5	$^\circ\text{C/W}$

P-Channel -60 V (D-S) MOSFET

Electrical Characteristics ($T_J=25^\circ\text{C}$ unless otherwise noted)

Symbol	Parameter	Conditions	Min	Typ	Max	Units
STATIC PARAMETERS						
BV_{DSS}	Drain-Source Breakdown Voltage	$I_D=-250\mu\text{A}$, $V_{GS}=0\text{V}$	-60			V
I_{DSS}	Zero Gate Voltage Drain Current	$V_{DS}=-48\text{V}$, $V_{GS}=0\text{V}$		-0.003	-1	μA
		$T_J=55^\circ\text{C}$			-5	
I_{GSS}	Gate-Body leakage current	$V_{DS}=0\text{V}$, $V_{GS}=\pm 20\text{V}$			± 100	nA
$V_{GS(th)}$	Gate Threshold Voltage	$V_{DS}=V_{GS}$, $I_D=-250\mu\text{A}$	-1.2	-1.9	-2.4	V
$I_{D(ON)}$	On state drain current	$V_{GS}=-10\text{V}$, $V_{DS}=-5\text{V}$	-60			A
$R_{DS(ON)}$	Static Drain-Source On-Resistance	$V_{GS}=-10\text{V}$, $I_D=-20\text{A}$		32	48	$\text{m}\Omega$
		$V_{GS}=-4.5\text{V}$, $I_D=-20\text{A}$		43	55	$\text{m}\Omega$
g_{FS}	Forward Transconductance	$V_{DS}=-5\text{V}$, $I_D=-20\text{A}$		32		S
V_{SD}	Diode Forward Voltage	$I_S=-1\text{A}$, $V_{GS}=0\text{V}$		-0.73	-1	V
I_S	Maximum Body-Diode Continuous Current				-30	A
DYNAMIC PARAMETERS						
C_{iss}	Input Capacitance	$V_{GS}=0\text{V}$, $V_{DS}=-30\text{V}$, $f=1\text{MHz}$		2977	3600	pF
C_{oss}	Output Capacitance			241		pF
C_{rss}	Reverse Transfer Capacitance			153		pF
R_g	Gate resistance	$V_{GS}=0\text{V}$, $V_{DS}=0\text{V}$, $f=1\text{MHz}$		2	2.4	Ω
SWITCHING PARAMETERS						
$Q_g(10\text{V})$	Total Gate Charge	$V_{GS}=-10\text{V}$, $V_{DS}=-30\text{V}$, $I_D=-20\text{A}$		44	54	nC
$Q_g(4.5\text{V})$	Total Gate Charge			22.2	28	nC
Q_{gs}	Gate Source Charge			9		nC
Q_{gd}	Gate Drain Charge			10		nC
$t_{D(on)}$	Turn-On Delay Time	$V_{GS}=-10\text{V}$, $V_{DS}=-30\text{V}$, $R_L=1.5\Omega$, $R_{GEN}=3\Omega$		12		ns
t_r	Turn-On Rise Time			14.5		ns
$t_{D(off)}$	Turn-Off Delay Time			38		ns
t_f	Turn-Off Fall Time			15		ns
t_{rr}	Body Diode Reverse Recovery Time		$I_F=-20\text{A}$, $dI/dt=100\text{A}/\mu\text{s}$		40	50
Q_{rr}	Body Diode Reverse Recovery Charge	$I_F=-20\text{A}$, $dI/dt=100\text{A}/\mu\text{s}$		59		nC

A: The value of $R_{\theta JA}$ is measured with the device mounted on 1in 2 FR-4 board with 2oz. Copper, in a still air environment with $T_A=25^\circ\text{C}$. The Power dissipation PDSM is based on $R_{\theta JA}$ and the maximum allowed junction temperature of 150°C . The value in any a given application depends on the user's specific board design, and the maximum temperature for 175°C may be used if the PCB allows it.

B: The power dissipation PD is based on $T_{J(MAX)}=175^\circ\text{C}$, using junction-to-case thermal resistance, and is more useful in setting the upper dissipation limit for cases where additional heatsinking is used.

C: Repetitive rating, pulse width limited by junction temperature $T_{J(MAX)}=175^\circ\text{C}$.

D: The $R_{\theta JA}$ is the sum of the thermal impedance from junction to case $R_{\theta JC}$ and case to ambient.

E: The static characteristics in Figures 1 to 6 are obtained using <300 ms pulses, duty cycle 0.5% max.

F: These curves are based on the junction-to-case thermal impedance which is measured with the device mounted to a large heatsink, assuming a maximum junction temperature of $T_{J(MAX)}=175^\circ\text{C}$.

G: The maximum current rating is limited by bond-wires.

H: These tests are performed with the device mounted on 1 in 2 FR-4 board with 2oz. Copper, in a still air environment with $T_A=25^\circ\text{C}$. The SOA curve provides a single pulse rating.

P-Channel -60 V (D-S) MOSFET

TYPICAL ELECTRICAL AND THERMAL CHARACTERISTICS

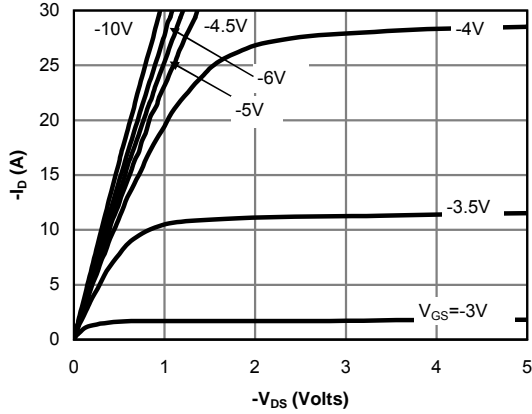

Fig 1: On-Region Characteristics

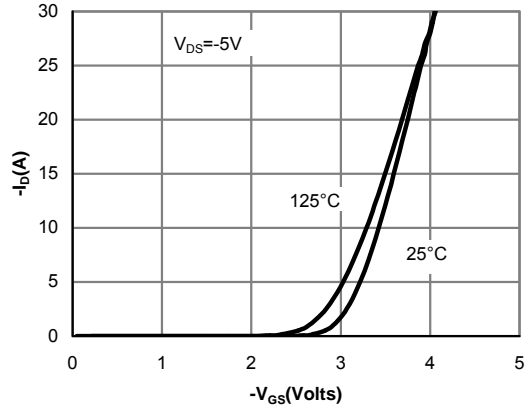

Figure 2: Transfer Characteristics

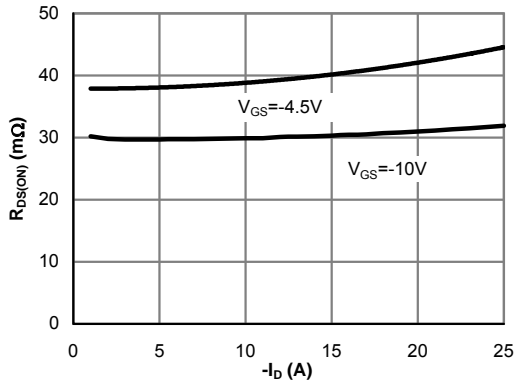

Figure 3: On-Resistance vs. Drain Current and Gate Voltage

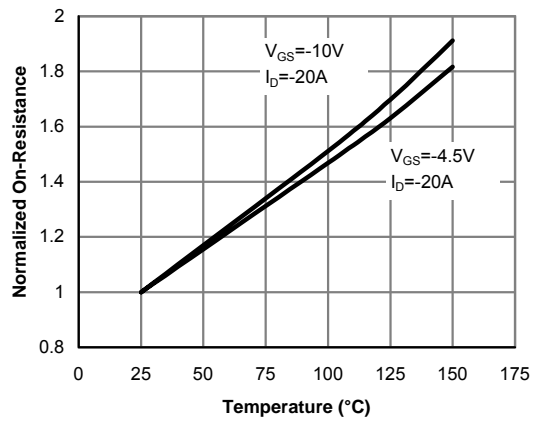

Figure 4: On-Resistance vs. Junction Temperature

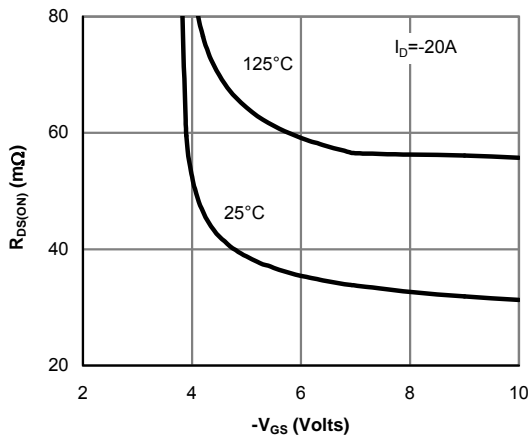

Figure 5: On-Resistance vs. Gate-Source Voltage

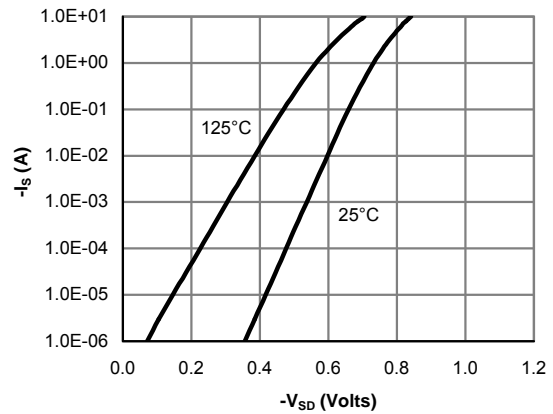

Figure 6: Body-Diode Characteristics

P-Channel -60 V (D-S) MOSFET

TYPICAL ELECTRICAL AND THERMAL CHARACTERISTICS

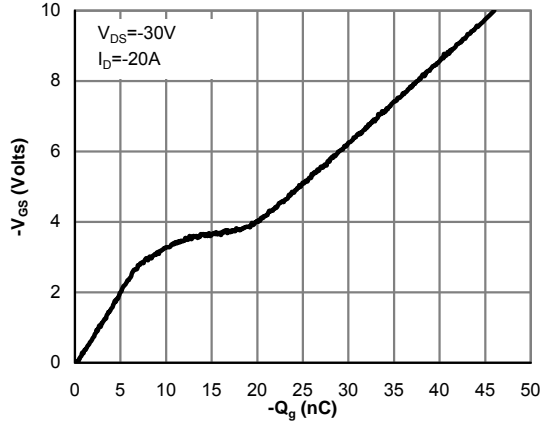

Figure 7: Gate-Charge Characteristics

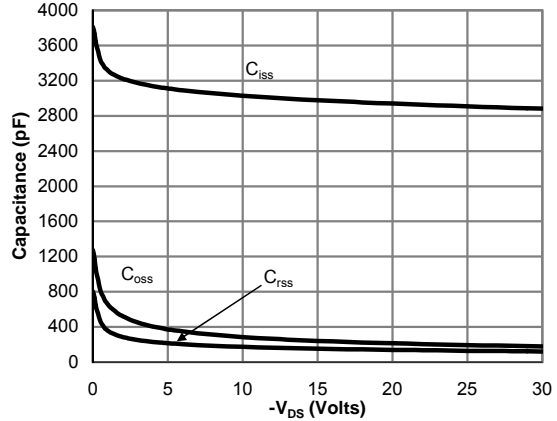

Figure 8: Capacitance Characteristics

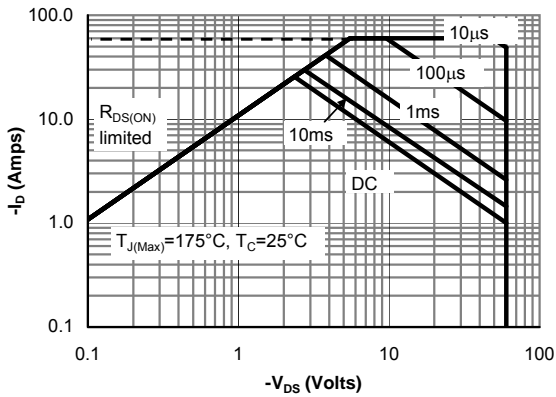

Figure 9: Maximum Forward Biased Safe Operating Area (Note F)

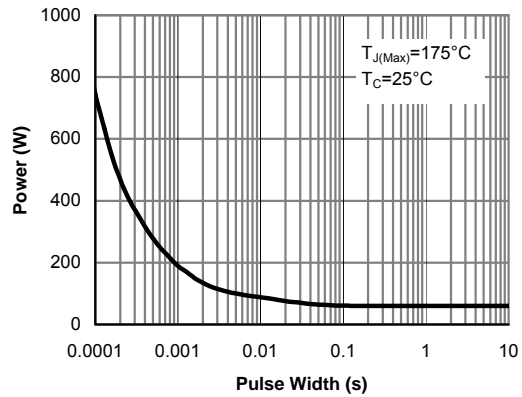

Figure 10: Single Pulse Power Rating Junction-to-Case (Note F)

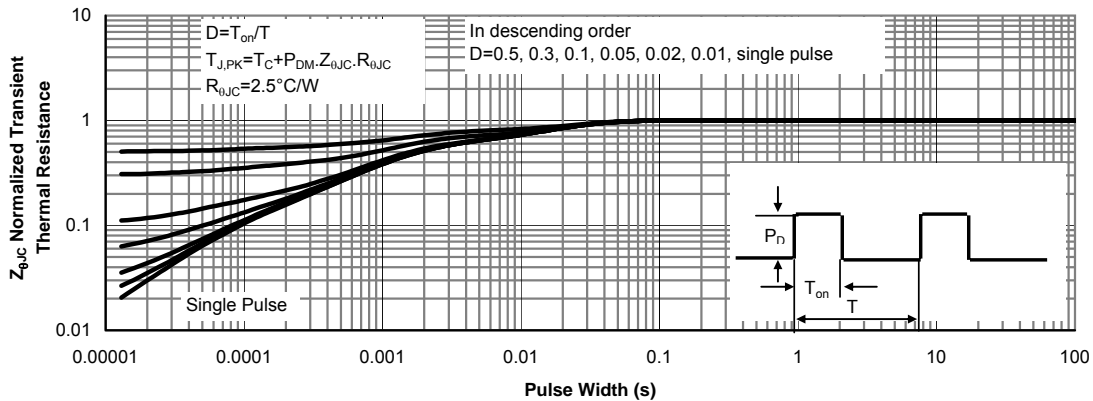

Figure 11: Normalized Maximum Transient Thermal Impedance (Note F)

P-Channel -60 V (D-S) MOSFET

TYPICAL ELECTRICAL AND THERMAL CHARACTERISTICS

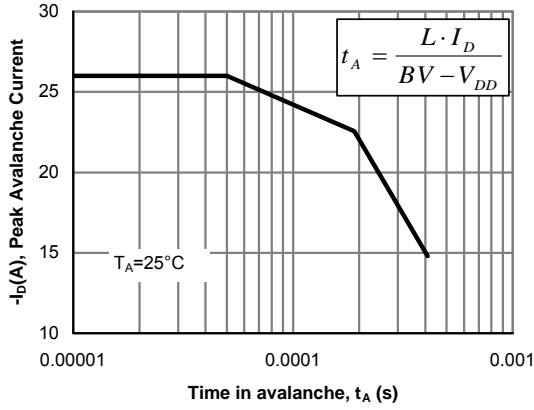

Figure 12: Single Pulse Avalanche capability

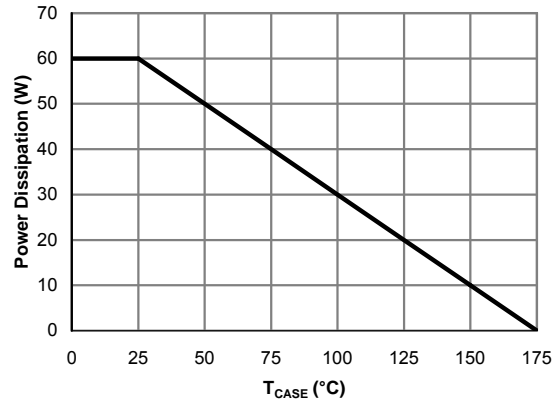

Figure 13: Power De-rating (Note B)

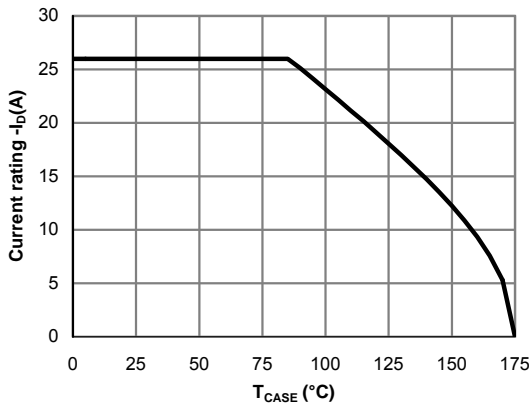

Figure 14: Current De-rating (Note B)

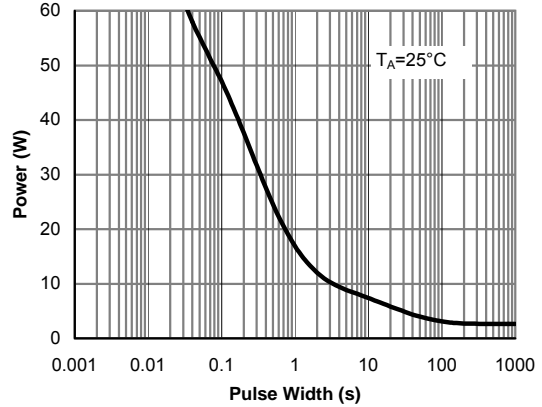

Figure 15: Single Pulse Power Rating Junction-to-Ambient (Note H)

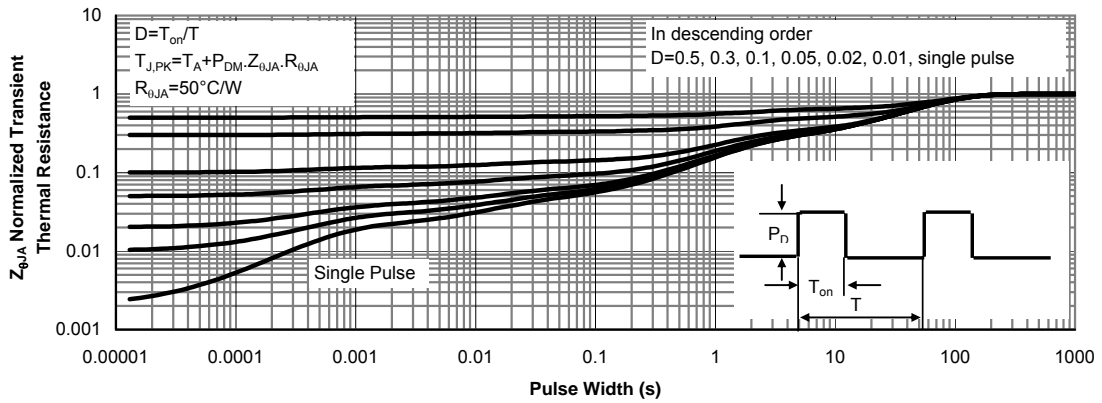
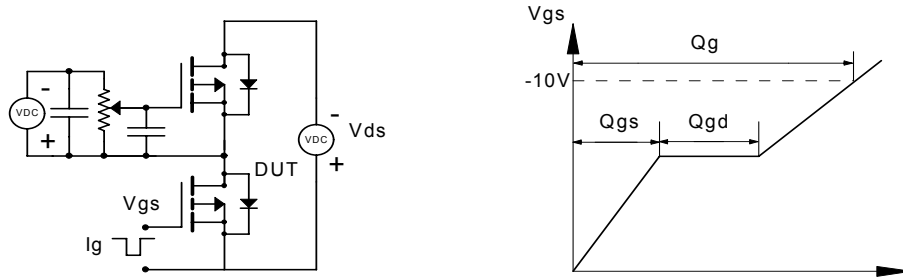

Figure 16: Normalized Maximum Transient Thermal Impedance (Note H)

P-Channel -60 V (D-S) MOSFET

Gate Charge Test Circuit & Waveform



Resistive Switching Test Circuit & Waveforms

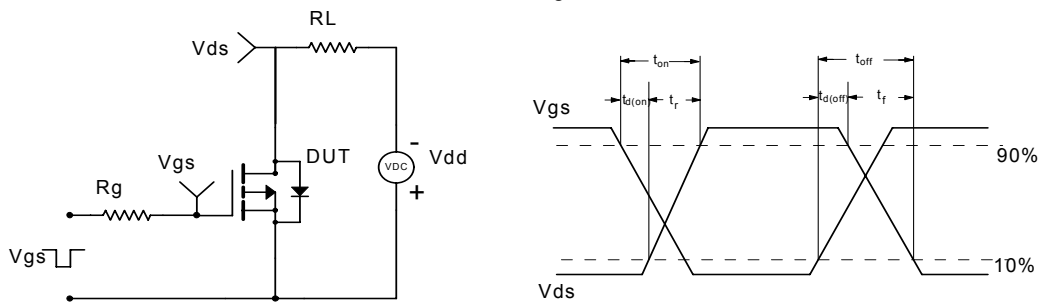

Unclamped Inductive Switching (UIS) Test Circuit & Waveforms

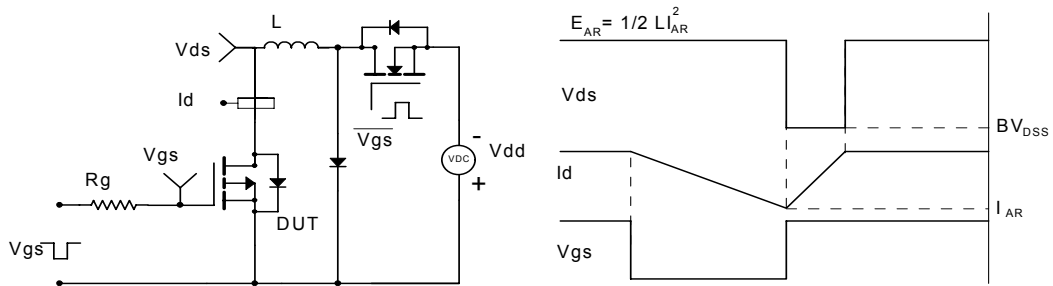

Diode Recovery Test Circuit & Waveforms

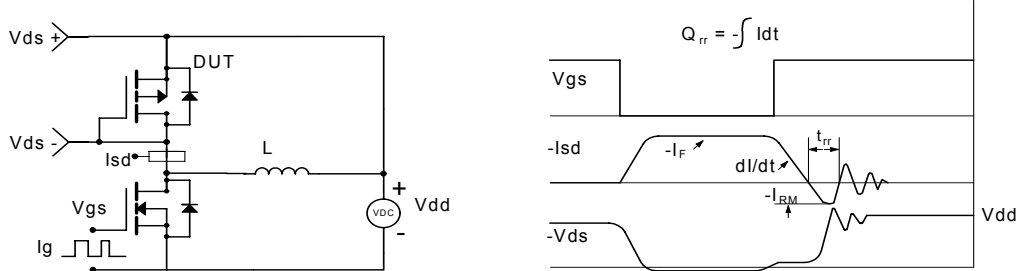

P-Channel -60 V (D-S) MOSFET

Package Mechanical Data TO-252

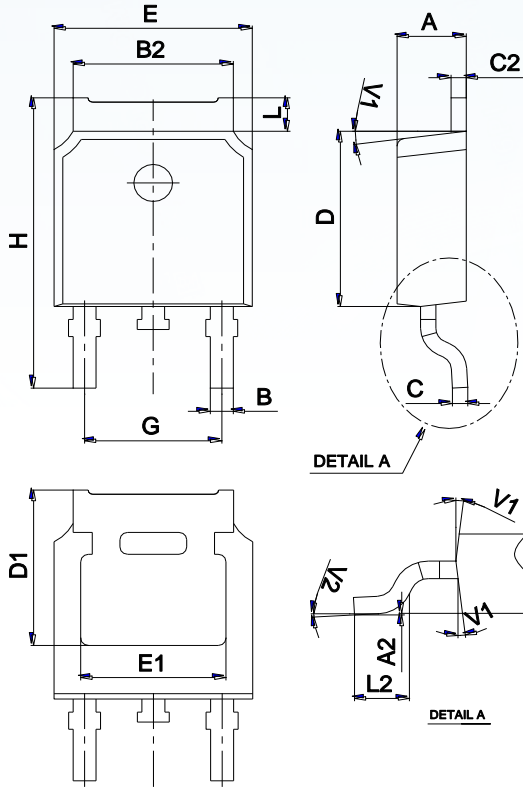

Ref.	Dimensions					
	Millimeters			Inches		
	Min.	Typ.	Max.	Min.	Typ.	Max.
A	2.10		2.50	0.083		0.098
A2	0		0.10	0		0.004
B	0.66		0.86	0.026		0.034
B2	5.18		5.48	0.202		0.216
C	0.40		0.60	0.016		0.024
C2	0.44		0.58	0.017		0.023
D	5.90		6.30	0.232		0.248
D1	5.30REF			0.209REF		
E	6.40		6.80	0.252		0.268
E1	4.63			0.182		
G	4.47		4.67	0.176		0.184
H	9.50		10.70	0.374		0.421
L	1.09		1.21	0.043		0.048
L2	1.35		1.65	0.053		0.065
V1		7°			7°	
V2	0°		6°	0°		6°

Marking

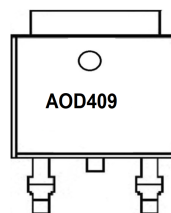

Ordering information

Order code	Package	Baseqty	Deliverymode
AOD409	TO-252	2500	Tape and reel

Disclaimer

EVVOSEMI ("EVVO") reserves the right to make corrections, enhancements, improvements, and other changes to its products and services at any time, and to discontinue any product or service without notice.

EVVO warrants the performance of its hardware products to the specifications applicable at the time of sale in accordance with its standard warranty. Testing and other quality control techniques are used as deemed necessary by EVVO to support this warranty. Except where mandated by government requirements, testing of all parameters of each product is not necessarily performed.

Customers should obtain and confirm the latest product information and specifications before final design, purchase, or use. EVVO makes no warranty, representation, or guarantee regarding the suitability of its products for any particular purpose, nor does EVVO assume any liability for application assistance or customer product design. EVVO does not warrant or accept any liability for products that are purchased or used for any unintended or unauthorized application.

EVVO products are not authorized for use as critical components in life support devices or systems without the express written approval of EVVOSEMI.

The EVVO logo and EVVOSEMI are trademarks of EVVOSEMI or its subsidiaries in relevant jurisdictions. EVVO reserves the right to make changes without further notice to any products herein.