

EVVOSEMI[®]

THINK CHANGE DO



ESD



TVS



MOS

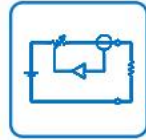

LDO

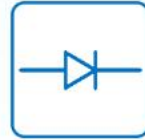

Diode

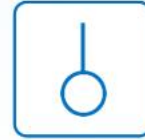

Sensor



DC-DC

Product Specification

▶ Domestic	Part Number	ESDONCAN1LT1G
▶ Overseas	Part Number	ESDONCAN1LT1G
▶ Equivalent	Part Number	ESDONCAN1LT1G

EV is the abbreviation of name EVVO

The ESDONCAN1L has been designed to protect the CAN transceiver from ESD and other harmful transient voltage events. This device provides bidirectional protection for each data line with a single compact SOT-23 package, giving the system designer a low cost option for improving system reliability and meeting stringent EMI requirements.

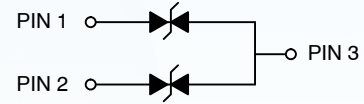

Features

- 200 W Peak Power Dissipation per Line (8 x 20 sec Waveform)
- Diode Capacitance Matching
- Low Reverse Leakage Current (< 100 nA)
- Low Capacitance High-Speed FlexRay Data Rates
- IEC Compatibility: – IEC 61000-4-2 (ESD): Level 4
 - IEC 61000-4-4 (EFT): 50 A – 5/50 ns
 - IEC 61000-4-5 (Lighting) 3.0 A (8/20 s)
- ISO 7637-1, Nonrepetitive EMI Surge Pulse 2, 8.0 A (1 x 50 s)
- ISO 7637-3, Repetitive Electrical Fast Transient (EFT) EMI Surge Pulses, 50 A (5 x 50 ns)
- Flammability Rating UL 94 V-0
- These are Pb-Free Devices

Typical Applications

- Industrial
 - ◆ Smart Distribution Systems (SDS)
 - ◆ DeviceNet

MAXIMUM RATINGS (T_J = 25°C, unless otherwise specified)

Symbol	Rating	Value	Unit
PPK	Peak Power Dissipation, 8 x 20 μs Double Exponential Waveform (Note 1)	200	W
T _J	Operating Junction Temperature Range	-55 to 150	°C
T _J	Storage Temperature Range	-55 to 150	°C
T _L	Lead Solder Temperature (10 s)	260	°C
ESD	Human Body Model (HBM) Machine Model (MM) IEC 61000-4-2 Specification (Contact)	8.0 400 23	kV V kV

Stresses exceeding those listed in the Maximum Ratings table may damage the device. If any of these limits are exceeded, device functionality should not be assumed, damage may occur and reliability may be affected.

1. Non-repetitive current pulse per Figure 1.

ELECTRICAL CHARACTERISTICS (T_J = 25°C, unless otherwise specified)

Symbol	Parameter	Test Conditions	Min	Typ	Max	Unit
V _{RWM}	Reverse Working Voltage	(Note 2)	24	-	-	V
V _{BR}	Breakdown Voltage	I _T = 1 mA (Note 3)	26.2	-	32	V
I _R	Reverse Leakage Current	V _{RWM} = 24 V	-	15	100	nA
V _C	Clamping Voltage	I _{PP} = 1 A (8 x 20 μs Waveform) (Note 4)	-	33.4	36.6	V
V _C	Clamping Voltage	I _{PP} = 3 A (8 x 20 μs Waveform) (Note 4)	-	44	50	V
I _{PP}	Maximum Peak Pulse Current	8 x 20 μs Waveform (Note 4)	-	-	3.0	A
C _J	Capacitance	V _R = 0 V, f = 1 MHz (Line to GND)	-	-	10	pF
ΔC	Diode Capacitance Matching	V _R = 0 V, 5 MHz (Note 5)	-	0.26	2	%

Product parametric performance is indicated in the Electrical Characteristics for the listed test conditions, unless otherwise noted. Product performance may not be indicated by the Electrical Characteristics if operated under different conditions.

- Surge protection devices are normally selected according to the working peak reverse voltage (V_{RWM}), which should be equal or greater than the DC or continuous peak operating voltage level.
- V_{BR} is measured at pulse test current I_T.
- Pulse waveform per Figure 1.
- ΔC is the percentage difference between C_J of lines 1 and 2 measured according to the test conditions given in the electrical characteristics table.

TYPICAL PERFORMANCE CURVES

(T_J = 25°C unless otherwise noted)

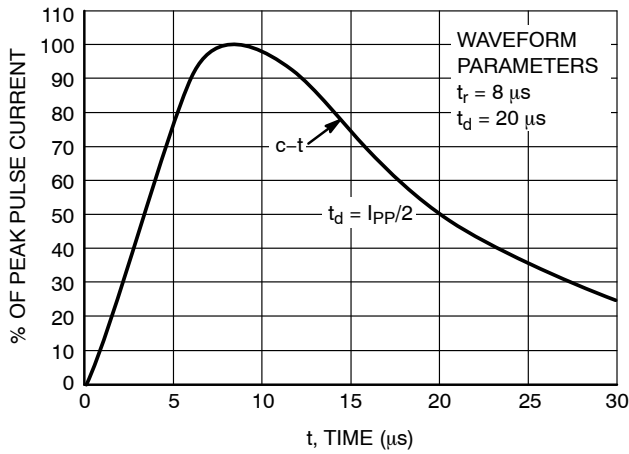

Figure 1. Pulse Waveform, 8 × 20 μs

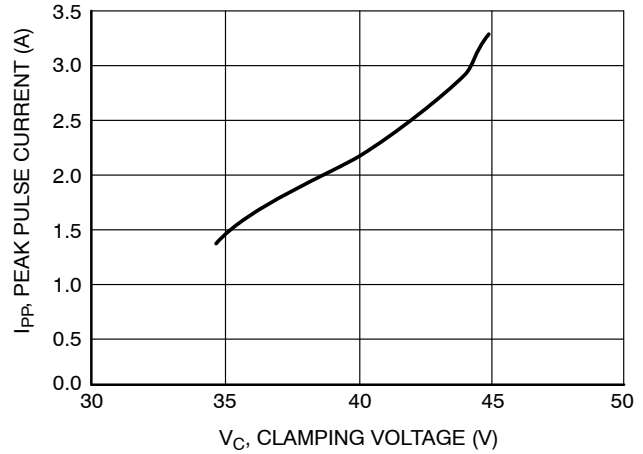

Figure 2. Clamping Voltage vs Peak Pulse Current

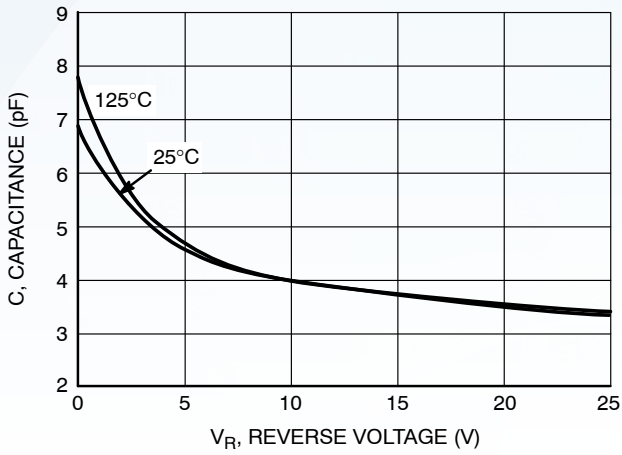

Figure 3. Typical Junction Capacitance vs Reverse Voltage

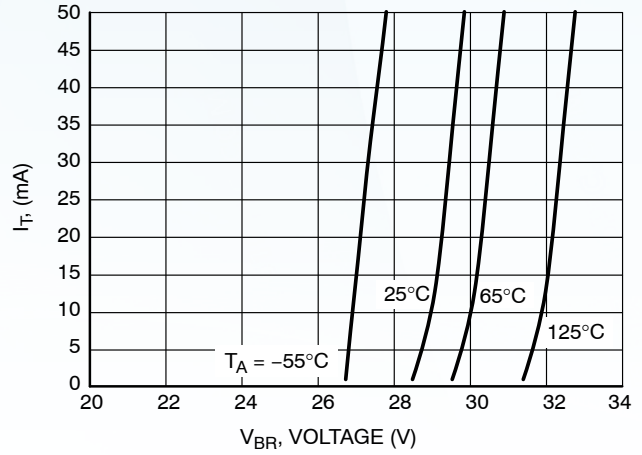

Figure 4. V_{BR} versus I_T Characteristics

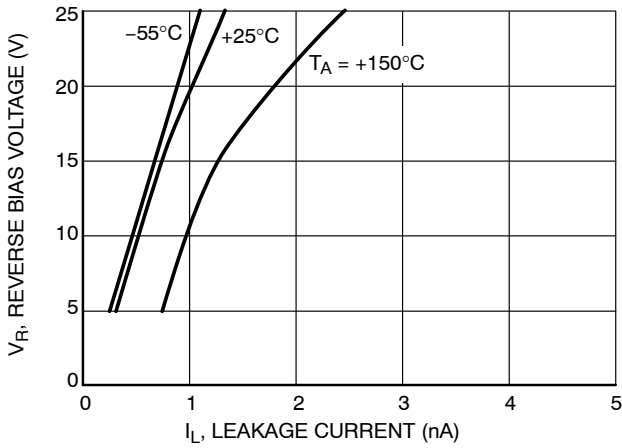

Figure 5. I_R versus Temperature Characteristics

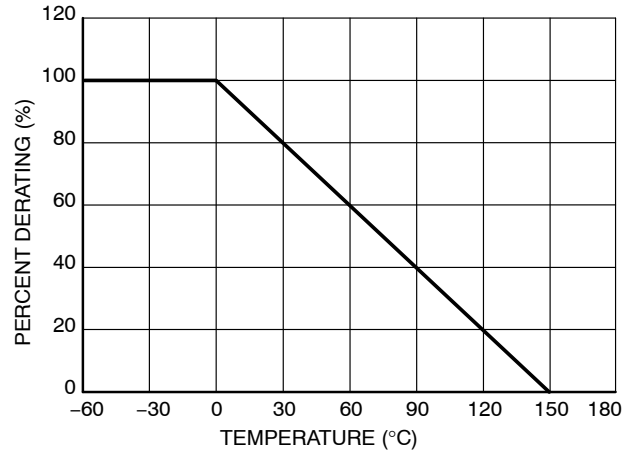
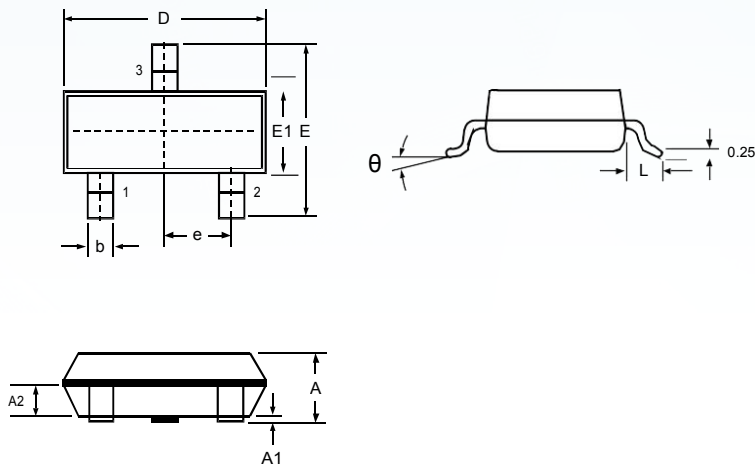

Figure 6. Temperature Power Dissipation Derating

Outline Drawing – SOT-23



SYMBOL	DIMENSIONS			
	MILLIMETER		INCHES	
	MIN	MAX	MIN	MAX
A	0.900	1.150	0.035	0.045
A1	0.000	0.100	0.000	0.004
A2	0.900	1.050	0.035	0.041
D	2.800	3.000	0.110	0.118
b	0.300	0.500	0.012	0.020
E	2.250	2.550	0.089	0.100
E1	1.200	1.400	0.047	0.055
e	0.950 BSC		0.037 BSC	
L	0.500	0.675	0.020	0.027
θ	0	8°	0	8°

Marking



Ordering information

Order code	Package	Baseqty	Delivery mode
ESDONCAN1LT1G	SOT-23	3000	Tape and reel

Disclaimer

EVVOSEMI ("EVVO") reserves the right to make corrections, enhancements, improvements, and other changes to its products and services at any time, and to discontinue any product or service without notice.

EVVO warrants the performance of its hardware products to the specifications applicable at the time of sale in accordance with its standard warranty. Testing and other quality control techniques are used as deemed necessary by EVVO to support this warranty. Except where mandated by government requirements, testing of all parameters of each product is not necessarily performed.

Customers should obtain and confirm the latest product information and specifications before final design, purchase, or use. EVVO makes no warranty, representation, or guarantee regarding the suitability of its products for any particular purpose, nor does EVVO assume any liability for application assistance or customer product design. EVVO does not warrant or accept any liability for products that are purchased or used for any unintended or unauthorized application.

EVVO products are not authorized for use as critical components in life support devices or systems without the express written approval of EVVOSEMI.

The EVVO logo and EVVOSEMI are trademarks of EVVOSEMI or its subsidiaries in relevant jurisdictions. EVVO reserves the right to make changes without further notice to any products herein.