

EVVOSEMI[®]

THINK CHANGE DO



ESD



TVS



MOS



LDO



Diode



Sensor



DC-DC

Product Specification

▶ Domestic	Part Number	IRFR4105Z
▶ Overseas	Part Number	IRFR4105Z
▶ Equivalent	Part Number	IRFR4105Z

EV is the abbreviation of name EVVO

V _{DSS} (V)	R _{DS (ON)}	I _{D(A)}
60	11mΩ(Typ)@V _{GS} =10V	58
	14mΩ(Typ)@V _{GS} =4.5V	

FEATURE:

- The IRFR4105Z is the high cell density trench N-ch MOSFETS, which provides excellent R_{DS(ON)} and efficiency for most of the small power switching and load switch applications.

APPLICATIONS:

- Load Switch

Pin Description

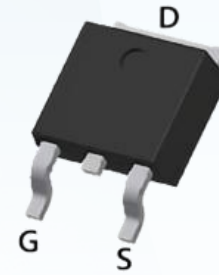

TO-252

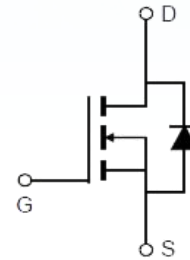

Absolute Maximum Ratings

Symbol	Parameter	Rating	Units
V _{DSS}	Drain-Source Voltage	60	V
V _{GSS}	Gate-Source Voltage	±20	V
I _D	Continuous Drain Current(V _{GS} = -4.5V)	T _A =25°C	58
		T _A =70°C	43
T _J	Maximum Junction Temperature	150	°C
T _{STG}	Storage Temperature Range	-55 to 150	°C
I _{DM}	Pulsed Drain Current	180	A
P _D	Maximum Power Dissipation	T _A =25°C	60
		T _A =70°C	---
E _{AS}	Avalanche Energy, Single Pulsed	36	mJ
R _{θJC}	Thermal Resistance-Junction to Case	1.6	°C/W
R _{θJA}	Thermal Resistance-Junction to Ambient	---	°C/W

Electrical Characteristics (T_A=25°C Unless Otherwise Noted)

Symbol	Parameter	Conditions	Min.	Typ.	Max.	Unit
Static Characteristics						
BVDSS	Drain-Source Breakdown Voltage	VGS=0V, ID=250uA	60	---	---	V
VGS(th)	Gate threshold voltage	VDS=VGS, ID=250uA	1.0	1.6	2.5	V
RDS(on)	Drain-Source On-state Resistance	VGS=10V, ID=20A	---	11	14	mΩ
		VGS=4.5V, ID=10A	---	14	20	mΩ
IGSS	Gate-source leakage current	VGS=±20V, VDS=0V	---	---	±100	nA
IDSS	Zero gate voltage drain current	VDS=60V, VGS=0V, T _J =25°C	---	---	1	μA
		T _J =55°C	---	---	---	
Dynamic Characteristic						
Ciss	Input Capacitance	VGS=0V, VDS=25V, Frequency=1.0MHz	---	2420	---	pF
Coss	Output Capacitance		---	230	---	
Crss	Reverse Transfer Capacitance		---	8	---	
QG	Gate Total Charge	VDS=30V, VGS=10V, IDS=20A	---	22	---	nC
Qgs	Gate-Source charge		---	4.5	---	
Qgd	Gate-Drain charge		---	3.5	---	
td(on)	Turn-on delay time	VDD=30V, VGS=10V, RG=1.6Ω, ID=20A	---	4.5	---	ns
tr	Turn-on Rise Time		---	5.2	---	
td(off)	Turn-off Delay Time		---	38	---	
tf	Turn-off Fall Time		---	27	---	
RG	Gate Resistance	VGS=0V, VDS=0V, F=1MHz	---	---	---	Ω
Diode Characteristics						
VSD	Diode Forward Voltage	VGS=0V, IS=1A, T _J =25°C	---	---	1.2	V
trr	Reverse Recovery Time	ISD=4.1A, dISD/dt=-100A/μs	---	18	---	ns
Qrr	Reverse Recovery Charge		---	12	---	nC

TYPICAL ELECTRICAL AND THERMAL CHARACTERISTICS

Figure 1: Output Characteristics

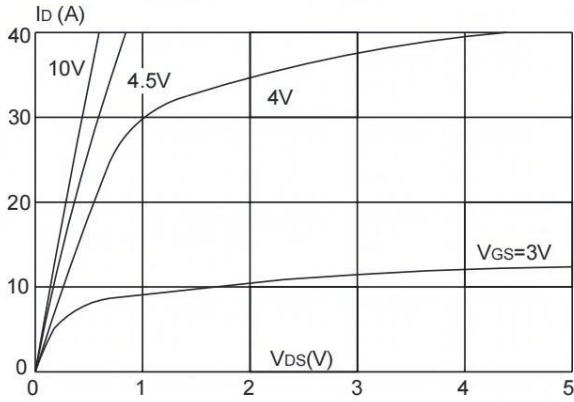

Figure 2: Typical Transfer Characteristics

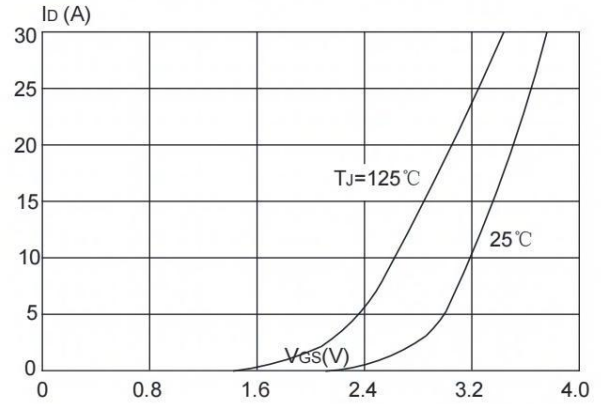

Figure 3: On-resistance vs. Drain Current

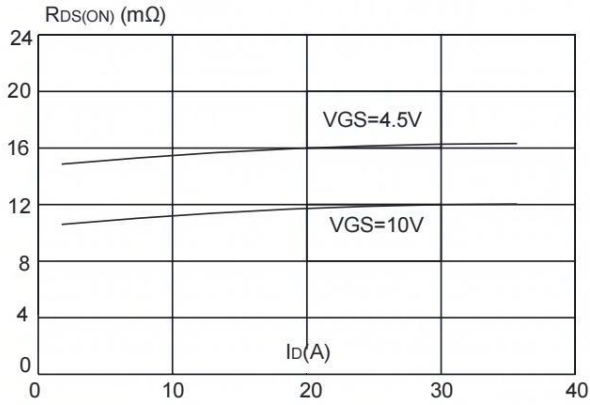

Figure 4: Body Diode Characteristics

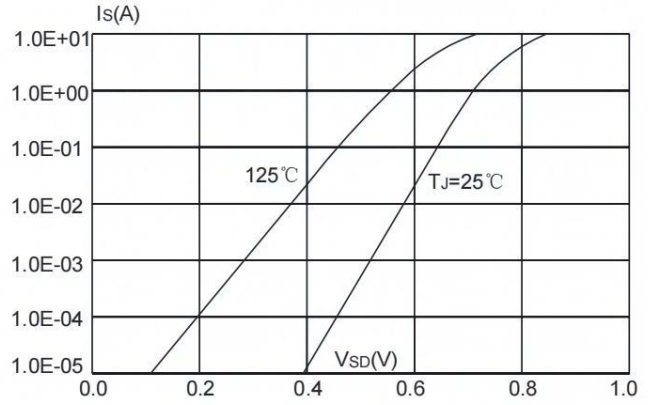

Figure 5: Gate Charge Characteristics

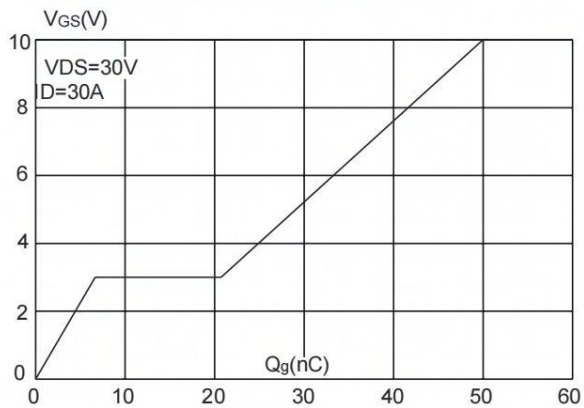

Figure 6: Capacitance Characteristics

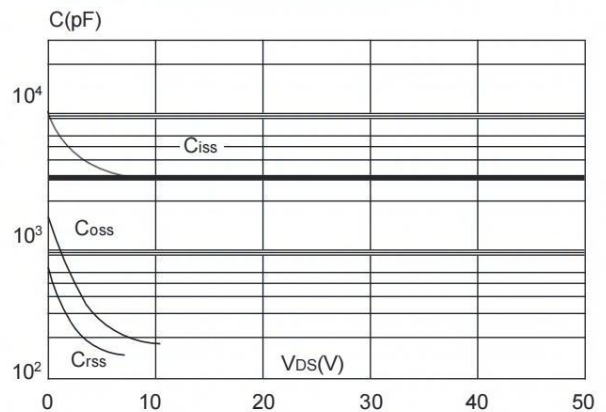

Figure 7: Normalized Breakdown Voltage vs. Junction Temperature

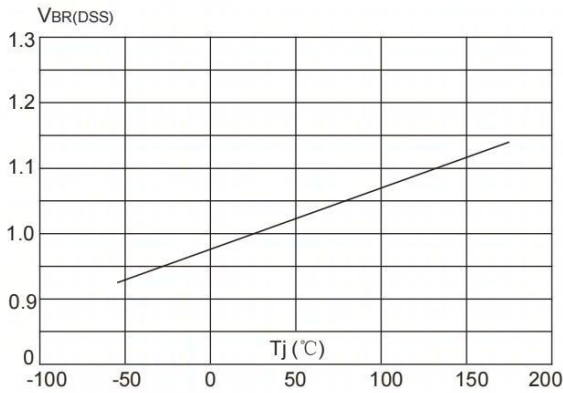

Figure 8: Normalized on Resistance vs. Junction Temperature

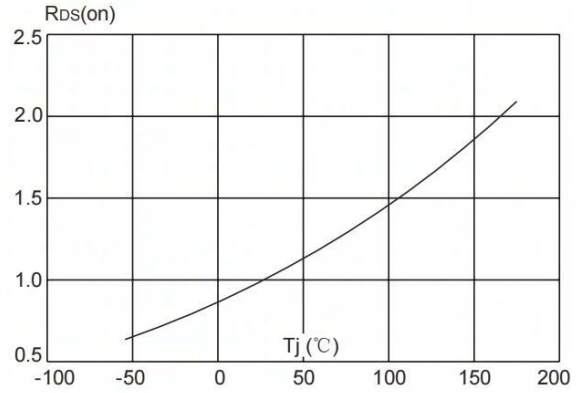

Figure 9: Maximum Safe Operating Area

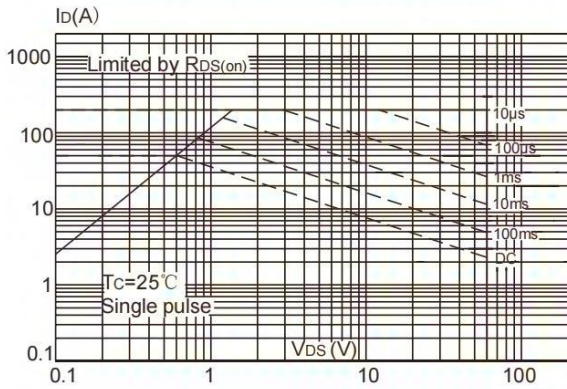

Figure 10: Maximum Continuous Drain Current vs. Case Temperature

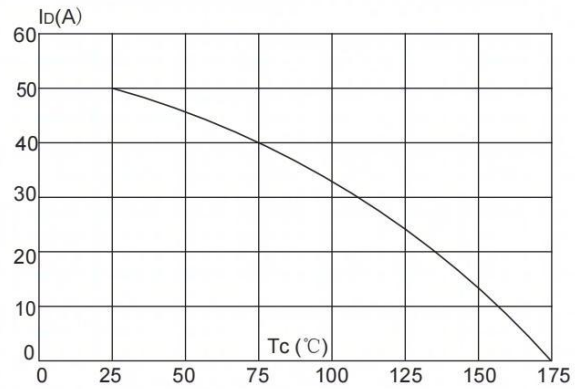
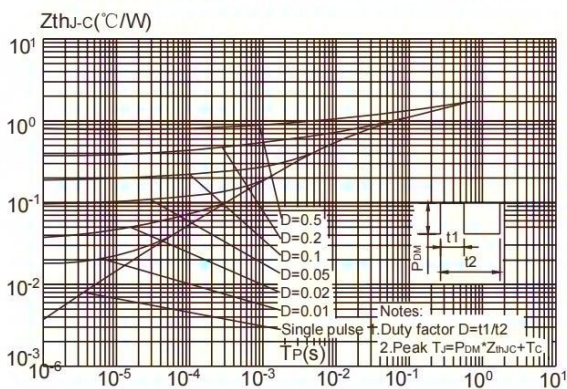
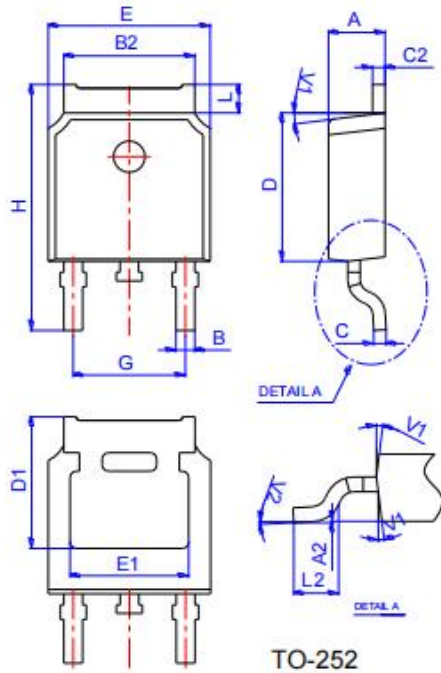

Figure 11: Maximum Effective Transient Thermal Impedance, Junction-to-Case



Package Mechanical Data:TO-252-3L



Ref.	Dimensions					
	Millimeters			Inches		
	Min.	Typ.	Max.	Min.	Typ.	Max.
A	2.10		2.50	0.083		0.098
A2	0		0.10	0		0.004
B	0.66		0.86	0.026		0.034
B2	5.18		5.48	0.202		0.216
C	0.40		0.60	0.016		0.024
C2	0.44		0.58	0.017		0.023
D	5.90		6.30	0.232		0.248
D1	5.30REF			0.209REF		
E	6.40		6.80	0.252		0.268
E1	4.63			0.182		
G	4.47		4.67	0.176		0.184
H	9.50		10.70	0.374		0.421
L	1.09		1.21	0.043		0.048
L2	1.35		1.65	0.053		0.065
V1		7°			7°	
V2		0°	6°		0°	6°

Reel Specification-TO-252

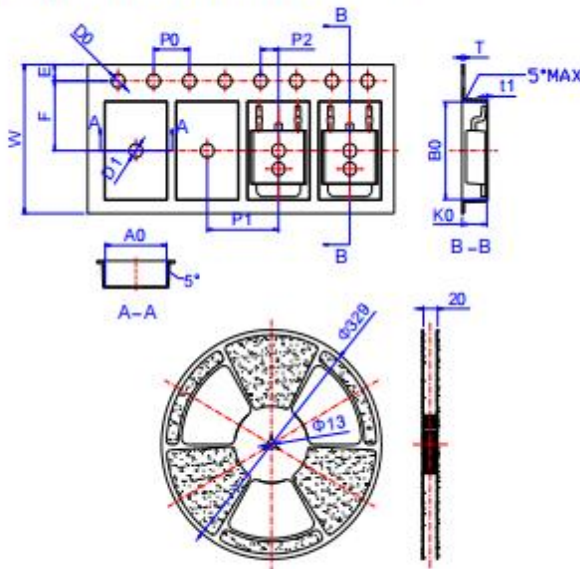

Ref.	Dimensions					
	Millimeters			Inches		
	Min.	Typ.	Max.	Min.	Typ.	Max.
W	15.90	16.00	16.10	0.626	0.630	0.634
E	1.65	1.75	1.85	0.065	0.069	0.073
F	7.40	7.50	7.60	0.291	0.295	0.299
D0	1.40	1.50	1.60	0.055	0.059	0.063
D1	1.40	1.50	1.60	0.055	0.059	0.063
P0	3.90	4.00	4.10	0.154	0.157	0.161
P1	7.90	8.00	8.10	0.311	0.315	0.319
P2	1.90	2.00	2.10	0.075	0.079	0.083
A0	6.85	6.90	7.00	0.270	0.271	0.276
B0	10.45	10.50	10.60	0.411	0.413	0.417
K0	2.68	2.78	2.88	0.105	0.109	0.113
T	0.24		0.27	0.009		0.011
t1	0.10			0.004		
10P0	39.80	40.00	40.20	1.567	1.575	1.583

Disclaimer

EVVOSEMI ("EVVO") reserves the right to make corrections, enhancements, improvements, and other changes to its products and services at any time, and to discontinue any product or service without notice.

EVVO warrants the performance of its hardware products to the specifications applicable at the time of sale in accordance with its standard warranty. Testing and other quality control techniques are used as deemed necessary by EVVO to support this warranty. Except where mandated by government requirements, testing of all parameters of each product is not necessarily performed.

Customers should obtain and confirm the latest product information and specifications before final design, purchase, or use. EVVO makes no warranty, representation, or guarantee regarding the suitability of its products for any particular purpose, nor does EVVO assume any liability for application assistance or customer product design. EVVO does not warrant or accept any liability for products that are purchased or used for any unintended or unauthorized application.

EVVO products are not authorized for use as critical components in life support devices or systems without the express written approval of EVVOSEMI.

The EVVO logo and EVVOSEMI are trademarks of EVVOSEMI or its subsidiaries in relevant jurisdictions. EVVO reserves the right to make changes without further notice to any products herein.